

JVC



COMPACT VHS CAMCORDER

GR-AXM30

ENGLISH

Compact VHS

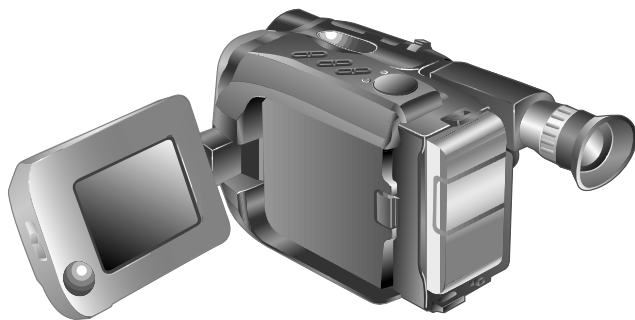

The Logical Choice



Compact VHS
VHS

*The only compact video
cassettes that can be
used with your VHS VCR**

*With Cassette Adapter

MAJOR FEATURES

- LCD Colour Monitor (☞ pg. 12)
- Programme AE with Special Effects (☞ pgs. 16, 17)
- Integrated Auto Light (☞ pg. 15)
- Variable-Speed Hyper Zoom (☞ pg. 14)
- EasyEdit with Random Assemble Editing (☞ pg. 33 – 35)

INSTRUCTIONS



LYT0002-0M9A

EN

Dear Customer,

Thank you for purchasing the JVC Compact VHS camcorder. Before use, please read the safety information and precautions contained in the following pages to ensure safe use of your new camcorder.

Using This Instruction Manual

- All major sections and subsections are listed in the Table Of Contents (☞ pg. 3).
- Notes appear after most subsections. Be sure to read these as well.
- Basic and advanced features/operation are separated for easier reference.

It is recommended that you . . .

- refer to the Index (☞ pgs. 42 – 44) and familiarize yourself with button locations, etc. before use.
- read thoroughly the Safety Precautions that follow and cautions (☞ pgs. 45, 46). They contain extremely important information regarding the safe use of your new camcorder.

SAFETY PRECAUTIONS

WARNING:
TO PREVENT FIRE OR SHOCK HAZARD, DO NOT EXPOSE THIS UNIT TO RAIN OR MOISTURE.

CAUTIONS:

- To prevent shock, do not open the cabinet. No user serviceable parts inside. Refer servicing to qualified personnel.
- When you are not using the AC Power Adapter/Battery charger for a long period of time, it is recommended that you disconnect the power cord from AC outlet.

This unit is produced to comply with Standard IEC Publ. 65.

Warning on lithium battery

The battery used in this device may present a fire or chemical burn hazard if mistreated. Do not recharge, disassemble, heat above 100°C or incinerate.

Replace battery with Panasonic (Matsushita Electric), Sanyo or Maxell CR2025; use of another battery may present a risk of fire or explosion.

- Dispose of used battery promptly.
- Keep away from children.
- Do not disassemble and do not dispose of in fire.

This camcorder is designed to be used with PAL-type colour television signals. It cannot be used for playback with a television of a different standard. However, live recording is possible anywhere. Use the BN-V12U/V22U/V25U battery packs and, to recharge them, the provided multi-voltage AC Power Adapter/Charger. (An appropriate conversion adapter may be necessary to accommodate different designs of AC outlets in different countries.)

NOTES:

- The rating plate (serial number plate) and safety caution are on the bottom and/or the back of the main unit.
- The rating plate (serial number plate) of the AC Power Adapter/Charger is on its bottom.



- Camcorder is designed exclusively for the VHS-C video cassette. Only cassettes marked VHS-C can be used with this unit.
- HQ VHS is compatible with existing VHS equipment.

- **LCD Colour Monitor** (☞ pg. 12)
- **Programme AE with Special Effects** (☞ pgs. 16, 17)
 - Auto Mode Lock
 - Auto Mode Release
 - Electronic Fog Filter • ND Effect
 - Sepia • Twilight • Sports
 - 1/1000 sec. High Speed Shutter
 - 1/2000 sec. High Speed Shutter
- **Integrated Auto Light** (☞ pg. 15)
- **Variable-Speed Hyper Zoom** (☞ pg. 14)
- **EasyEdit with Random Assemble Editing** (☞ pg. 33 – 35)

PROVIDED ACCESSORIES

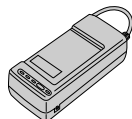

• AC Power Adapter/
Charger AA-V11EG



• Battery Pack
BN-V12U



• Shoulder Strap

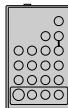

• Remote Control
Unit RM-V704U
or RM-V700U

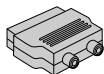

• Cable Adapter



• Lithium Battery
CR2025 x2

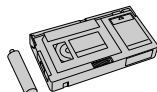

• Cassette Adapter
C-P7U



• AUDIO/VIDEO
(A/V) cable



• Editing cable



• DC cord

GETTING STARTED	4
Power	4
Clock (Lithium) Battery Insertion/Removal	6
Viewfinder Adjustment	6
Date/Time Setting	7
Tape Length Setting	8
Recording Mode Setting	8
Loading/Unloading A Cassette	8
Grip Adjustment	9
Shoulder Strap Attachment	9
Tripod Mounting	9
RECORDING	10
Basic Recording	10
Basic Features	14
Advanced Features	16
PLAYBACK	28
Basic Playback	28
Features	29
Basic Connections	30
Using The Cassette Adapter	31
EDITING	32
Tape Dubbing	32
Random Assemble Editing [R.A.Edit]	33
USING REMOTE CONTROL UNIT	36
Insert Editing	38
Audio Dubbing	39
TROUBLESHOOTING	40
INDEX	42
Controls	42
Connectors	42
Indicators	42
Other Parts	42
LCD monitor/Viewfinder	44
CAUTIONS	45
SPECIFICATIONS	47

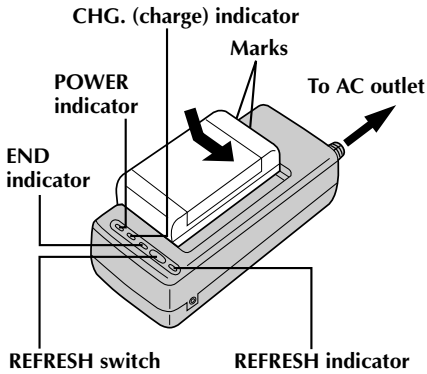

Charge marker

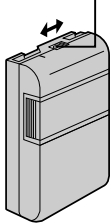

**** CHARGE MARKER**
A charge marker is provided on the battery pack to help you remember whether it has been charged or not. Two colours are provided (red and black)—you choose which one means charged and which means discharged.

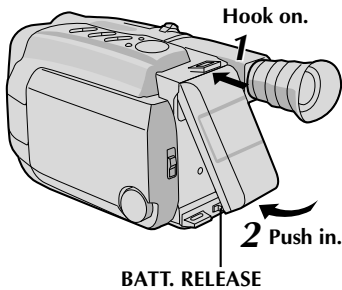

ATTENTION:

Before detaching the power source, make sure that the camcorder's power is turned off. Failure to do so can result in a camcorder malfunction.

****REFRESH**

The AC power adapter features a REFRESH function that allows you to fully discharge the battery pack before recharging.

To discharge the battery . . .

... attach the battery pack to the adapter as shown in the illustration above. Then push REFRESH. The REFRESH indicator lights when discharging starts, and goes out when discharging is complete.

Power

This camcorder's 3-way power supply system lets you choose the most appropriate source of power.

NOTES:

- No function is available without power supply.
- Use only specified power supply.
- Do not use provided power supply units with other equipment.

CHARGING THE BATTERY PACK

SUPPLY POWER

1 Connect the charger's AC power cord to a wall outlet. The power indicator lights.

ATTACH BATTERY PACK

2 Align the marks and slide the battery pack in the direction of the arrow until it locks in place. The CHG. indicator lights.

DETACH BATTERY PACK

3 When charging is completed, the END indicator lights. Slide the battery pack opposite the direction of the arrow.

BATT. PACK	CHARGE	DISCHARGE
BN-V12U	approx. 1 hr. 10 min.	approx. 3 hrs. 30 min.
BN-V22U	approx. 2 hrs. 10 min.	approx. 7 hrs.
BN-V25U	approx. 2 hrs. 40 min.	approx. 10 hrs.

USING THE BATTERY PACK

ATTACH BATTERY PACK

1 Hook its top end to the camcorder and push the battery pack in until it locks in place.

DETACH BATTERY PACK

2 Slide BATT. RELEASE and pull out the battery pack.

Approximate recording time (unit: min.)

BATT. PACK	LCD monitor on/ Viewfinder off	LCD monitor off/ Viewfinder on
BN-V12U	50 (35)	55 (35)
BN-V22U	110 (75)	120 (80)
BN-V25U	150 (100)	160 (105)

(): when the video light is on.

NOTES:

- The recording time per charge is affected by such factors as the time spent in Record/Standby mode and the frequency of zooming. It is safer to have spare battery packs.
- Charging times noted on page 4 are for fully discharged battery pack, and discharging times are for fully charged battery pack.
- Charging and discharging times vary according to the ambient temperature and the status of the battery pack.
- Remember to set the charge marker after charging a battery pack or after detaching a discharged one from your camcorder.
- Perform the REFRESH function after no less than 5 chargings.
- High temperatures can damage the battery pack, so use only where good ventilation is available. Don't allow it to discharge in container, such as a bag.
- If you stop recharging or discharging partway through, make sure to remove the battery pack before unplugging the adapter's AC cord.
- Remove the battery pack from the adapter immediately after discharging.
- To avoid interference with reception, do not use the AC Power Adapter/Charger near a radio.
- Make sure you unplug the DC cord before charging or discharging the battery pack.
- A blinking CHG. indicator means that the battery pack has become hot. Wait until it cools down to continue.
- The CHG. indicator may not light properly with a brand new battery pack, or with one that's been stored for an extended period. In this case, remove and reattach the battery pack and recharge it. The CHG. indicator should light during recharging. If not, contact your nearest JVC dealer.

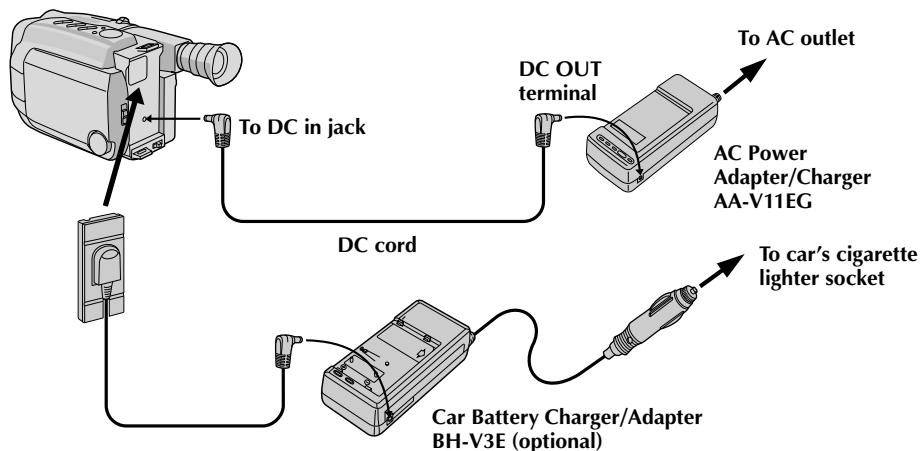
**USING A CAR BATTERY**

Use the Car Battery Charger/Adapter (connect as shown in the above illustration).

NOTES:

- When using the car battery, leave the engine idling.
- The optional Car Battery Charger (BH-V3E) can also be used to charge the battery pack.
- When using the optional Car Battery Charger, refer to the respective instruction booklet.

USING AC POWER

Use the AC Power Adapter (connect as shown in the above illustration).

NOTE:

The supplied AC Power Adapter/Charger features automatic voltage selection in the AC range from 110 V to 240 V.

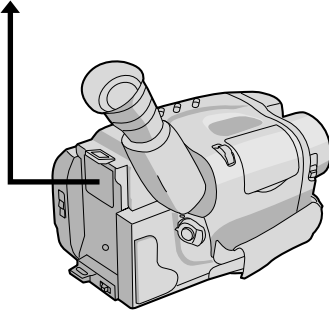
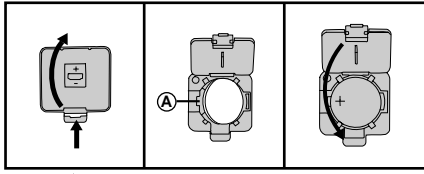

Clock (Lithium) Battery Insertion/Removal

This battery is necessary for clock operation and to perform date/time settings.

1 SWITCH OFF POWER

Switch off the unit's power and remove the power supply unit.

2 OPEN COVER

Open the clock battery compartment cover while pressing the release tab.

3 REMOVE BATTERY (when replacing)

Insert a pointed, non-metallic object between the battery and the compartment (A) and pull the battery out.

4 INSERT BATTERY

Ensuring the plus (+) side is up, insert a CR2025 lithium battery and push it in.

5 CLOSE COVER

Close the compartment cover until it clicks in place.

NOTE:

See "SAFETY PRECAUTIONS" (pg. 2) for information on safe handling of lithium batteries.

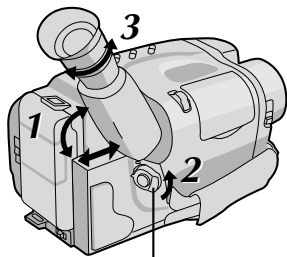

Set POWER to "CAMERA".

Viewfinder Adjustment

1 POSITION VIEWFINDER

Adjust the viewfinder manually for best viewability (see illustration at left).

2 SELECT MODE

Set the power switch to CAMERA.

3 ADJUST DIOPTR

Turn the dioptre adjustment control until the indications in the viewfinder are clearly focused.

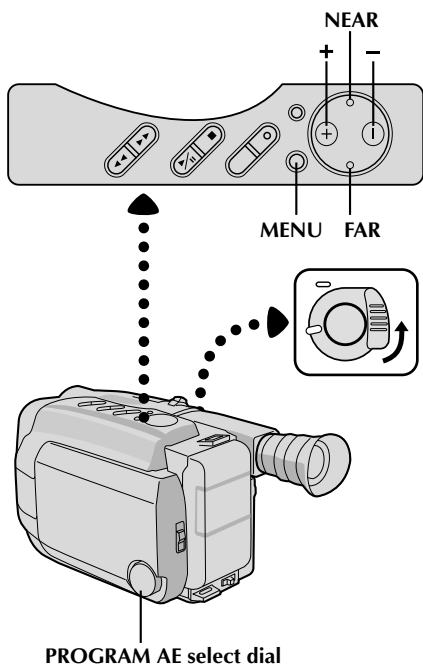

LCD monitor or viewfinder

Menu Screen

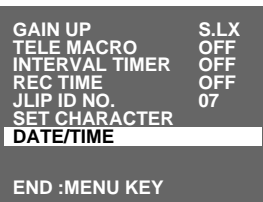

Set Time and Date Screen

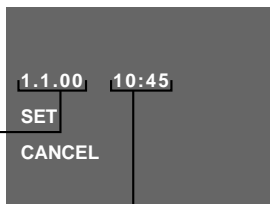

Date
Day/Month/Year

Time
24-hour indication

Date/Time Setting

- 1 SELECT MODE**
First set the power switch to "CAMERA". Turn the PROGRAM AE select dial to any position except AUTO LOCK.
- 2 ACCESS MENU SCREEN**
Press MENU.
- 3 SELECT FUNCTION**
Press - to move the highlight bar down to "DATE/TIME", then press NEAR. The Set Date And Time screen appears.
- 4 SET DATE/TIME**
Press FAR or NEAR until the item you want to set begins blinking, then press + or - to until the correct setting appears.
 - If you decide you want to return the date and time to the previous settings, press FAR or NEAR to move the highlight bar to "CANCEL", then press MENU.
 - If you're satisfied with the settings, go on to step 5.
- 5 START CLOCK OPERATION**
Once you've set the date and time, press FAR or NEAR until "SET" begins to blink, then press MENU. The Menu screen reappears.
- 6 CLOSE MENU**
Press MENU.

NOTES:

- To display the date and time in the LCD monitor or the viewfinder and on a connected TV, see "Date/Time Character Insert" (☞ pg. 22).
- If, in step 4, you input an invalid date (30. 2, 31. 6, etc.) and perform step 5, "INPUT ERROR" appears blinking at the bottom of the screen. Press +, -, FAR or NEAR to input the correct number.

T30•45•60 tape length select button

SP•LP recording mode button

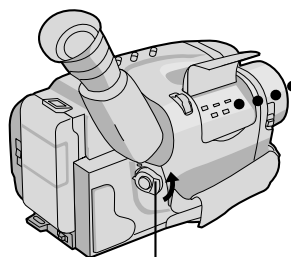

Set POWER to "CAMERA".

LCD monitor or viewfinder

Tape length indicator

T30 → T45 → T60

Recording mode indicator

SP ← LP

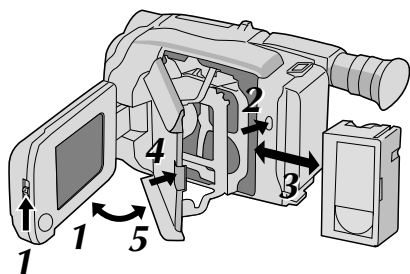

Erase Protection

Gear

Turn to take up slack.

Tape Length Setting

Set the tape length according to the length of the tape used.

1 SET TAPE LENGTH

- 1 Press T30•45•60 until the required indication appears in the LCD monitor or the viewfinder. T30 = 30 minutes of recording time, T45 = 45 minutes, and T60 = 60 minutes. (in SP)

NOTE:

The tape remaining time (☞ pg. 11) displayed in the LCD monitor or the viewfinder is correct only if the correct tape length has been selected.

Recording Mode Setting

Set depending on your preference.

1 SET RECORDING MODE

- 1 Press SP•LP button. "SP" (Standard Play) provides higher picture and sound quality and is better for dubbing, while "LP" (Long Play) is more economical, recording at 1/2 the speed of SP.

NOTE:

If the recording mode is switched during recording, the playback picture will be blurred at the switching point.

Loading/Unloading A Cassette

1 OPEN LCD MONITOR

- Slide MONITOR OPEN and open the LCD monitor to an angle of over 45 degrees.

2 OPEN CASSETTE HOLDER

- 2 Press EJECT until the holder opens. Do not use force to open.

3 INSERT/REMOVE CASSETTE

- 3 Make sure the label is facing outward.

4 CLOSE CASSETTE HOLDER

- 4 Press PUSH and make sure the holder is closed and locked.

5 CLOSE LCD MONITOR

- 5 First make sure the holder is closed. Then close the LCD monitor.

NOTES:

- Closing the LCD monitor while the cassette holder is still open may cause damage to the LCD monitor.
- A cassette holder can't be opened unless a power supply is attached.
- Make sure that the tape is not slack when loading the cassette. If there is any slack, turn the gear on the cassette in the direction of the arrow to take up the slack.
- Make sure the Erase Protection tab is in the position that allows recording. If not, slide the tab. Some cassettes have removable tabs. If the tab has been removed, cover the hole with adhesive tape.
- The cassette holder can't be opened while the camcorder is in the record mode.

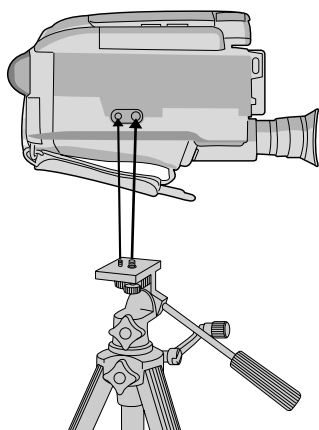
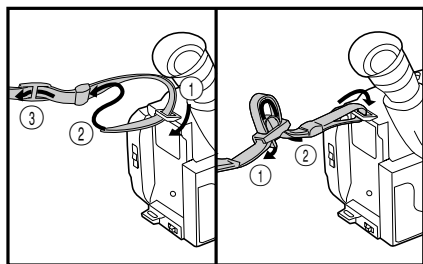
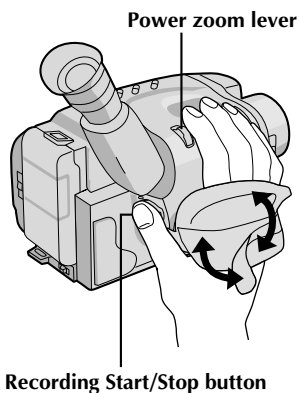

Grip Adjustment

EXPAND LOOP

- 1 Separate the Velcro strip.

INSERT HAND

- 2 Pass your right hand through the loop and grasp the grip.

ADJUST STRAP LENGTH

- 3 Adjust so your thumb and fingers can easily operate the Recording Start/Stop button and Power Zoom lever. Refasten the Velcro strip.

Shoulder Strap Attachment

ATTACH STRAP

- 1 Following the illustration at left, thread the strap through the top of the eyelet (1), then fold it back and thread it through the keeper (2), and then through the buckle (3). Repeat the procedure to attach the other end of the strap to the other eyelet, making sure the strap isn't twisted.

ADJUST LENGTH

- 2 Adjust as shown in the illustration at left (1), then slide both keepers snug against the eyelets to prevent slipping (2).

Tripod Mounting

ALIGN AND TIGHTEN

- 1 Align the screw and camera direction stud on the tripod with the camera's mounting socket and stud hole. Then tighten the screw.

CAUTION:

When using a tripod, be sure to open and extend its legs fully to stabilize the camcorder. To prevent damage to the unit caused by falling over, do not use a small-sized tripod.

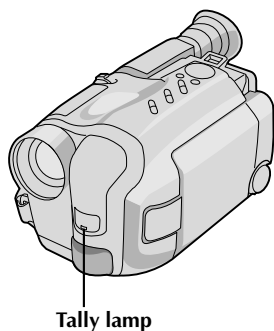
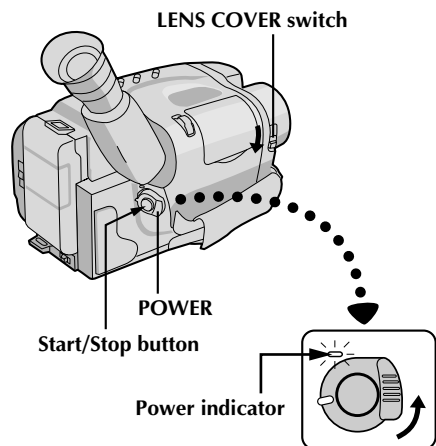
**NOTE:**

You should already have performed the procedures listed below. If not, do so before continuing.

- Power (☞ pg. 4)
- Tape Length Setting (☞ pg. 8)
- Recording Mode Setting (☞ pg. 8)
- Grip Adjustment (☞ pg. 9)

LOAD A CASSETTE

- 1** First slide MONITOR OPEN and open the LCD monitor to an angle of over 45 degrees. Press EJECT to open the cassette holder, then insert the cassette with the label facing out. Press PUSH to ensure the holder is closed and locked.

Shooting while watching the viewfinder**ENTER RECORD-STANDBY MODE**

- 2** Make sure the LCD monitor is closed and locked. Slide the LENS COVER open/close switch to open the lens cover, then set the power switch to CAMERA.

- The power indicator lights and the camcorder enters the Record-Standby mode.
- The scene you're aimed at appears on the viewfinder screen, with the word "PAUSE" superimposed upon it.

START SHOOTING

- 3** Press the Recording Start/Stop button.
- The tally lamp lights while recording is in progress, and "REC" appears in the viewfinder.

STOP RECORDING

4 Press the Recording Start/Stop button again to stop recording.

- The camcorder re-enters the Record-Standby mode.

NOTES:

- When the power switch is set to CAMERA and the LCD monitor is opened at an angle of 45 degrees or more, the LCD monitor switches on and the viewfinder switches off automatically to save power.
- A cassette holder can't be opened unless a power supply is attached.
- There may be a delay after you press EJECT until the holder opens. Do not use force.
- The tape's remaining time is displayed in the LCD monitor or the viewfinder as shown.
- The indicated remaining time is approximate.
- The time required to calculate the remaining tape length, and the accuracy of the calculation, may vary according to the type of tape used.
- The tape remaining time indicator is correct only if the correct tape length has been selected (☞ pg. 8).
- "TAPE END" appears when the tape reaches its end, and the power goes off automatically if left in this condition for 5 minutes. "TAPE END" also appears when a cassette whose tape is already at its end is loaded.
- While shooting, pressing **DISPLAY** lets you remove some indications from the screen (☞ pg. 44).
- If the Record-Standby mode continues for 5 minutes without performing Zoom or any other operations, the camcorder's power shuts off automatically. Set the Power switch to "POWER OFF", and then back to "CAMERA" to turn the camcorder on again.
- If the Recording Start/Stop button is pressed after the Record-Standby mode has continued for over 5 minutes, recording may not start immediately.
- If you're recording on a cassette from the middle, use the RETAKE function (☞ pg. 14) to find the end of the last recording so you don't erase any of it.
- The LENS COVER warning blinks for about 10 seconds when the camcorder is turned on when the cover is closed.
- While shooting, sound is not heard from the speaker.

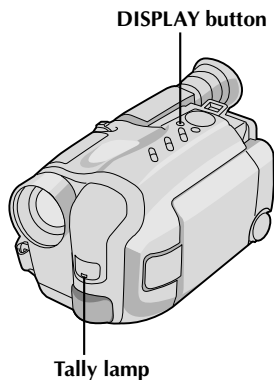
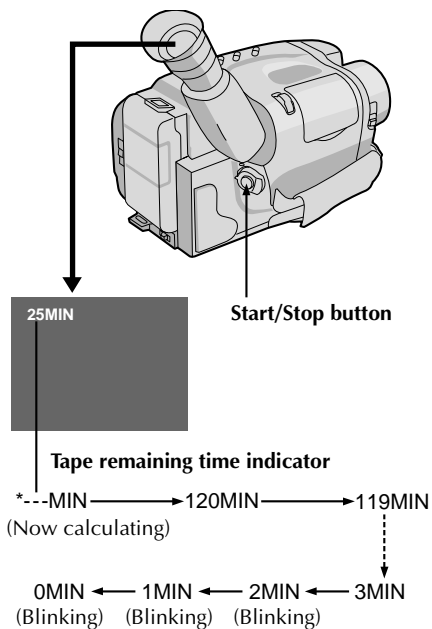

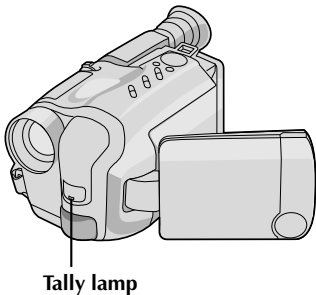
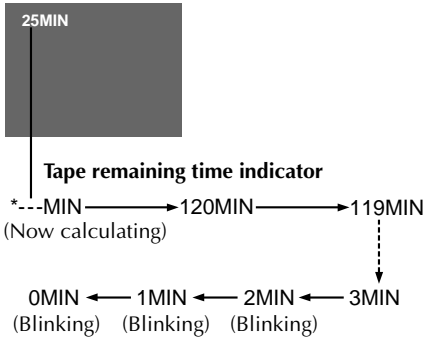
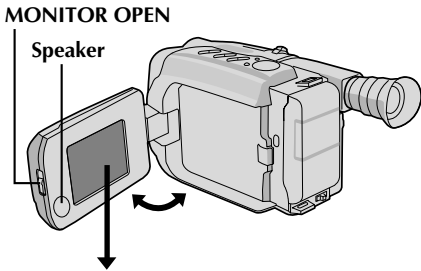
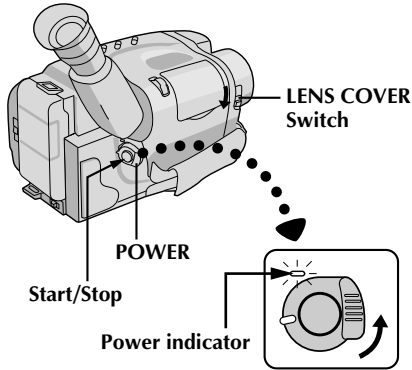

Shooting while watching the LCD monitor

Before the following steps, perform step 1 (pg. 10).

2 ENTER RECORD-STANDBY MODE

Make sure the LCD monitor is fully open. Slide the LENS COVER open/close switch to open the lens cover, then set the power switch to CAMERA.

- The power indicator lights and the camcorder enters the Record-Standby mode.
- The scene you're aimed at appears in the LCD monitor, with the word "PAUSE" superimposed upon it.

3 START SHOOTING

Tilt the LCD monitor upward/downward for best viewability (pg. 13) and press the Recording Start/Stop button.

- The tally lamp lights while recording is in progress, and "REC" appears in the LCD monitor.

4 STOP RECORDING

Press the Recording Start/Stop button again to stop recording.

- The camcorder re-enters the Record-Standby mode.

NOTES:

- When you use the LCD monitor outdoors in direct sunlight, the LCD monitor may be difficult to see. If this happens, we recommend that you use the viewfinder (pg. 10).
- For other notes, refer to pg. 11.



Journalistic shooting

In some situations different angles of shooting may be required for more dramatic results.

1

OPEN LCD MONITOR

Make sure the LCD monitor is fully open.

2

TILT LCD MONITOR

Tilt the LCD monitor in the most convenient direction.

- The LCD monitor can rotate almost full circle (270°: 90° downward, 180° upward).



Self-recording

You can shoot yourself while viewing your own image in the LCD monitor.

1

TILT LCD MONITOR UPWARD

Open the LCD monitor and tilt it upward to 180 degrees so that it faces forward.

2

START RECORDING

Point the lens toward yourself and start recording.

- During self-recording, the monitor image and indications do not appear inverted as when viewing a mirror.

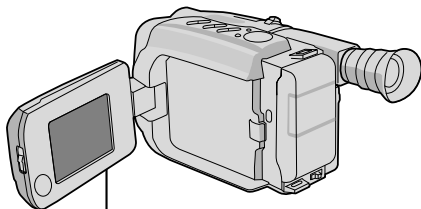

BRIGHT dial

Brightness control

You can adjust the brightness of the LCD monitor by turning the **BRIGHT** dial.

1

ADJUST BRIGHTNESS

If you want to brighten the image . . .

Turn the dial towards "+".

If you want to darken the image . . .

Turn the dial towards "-".

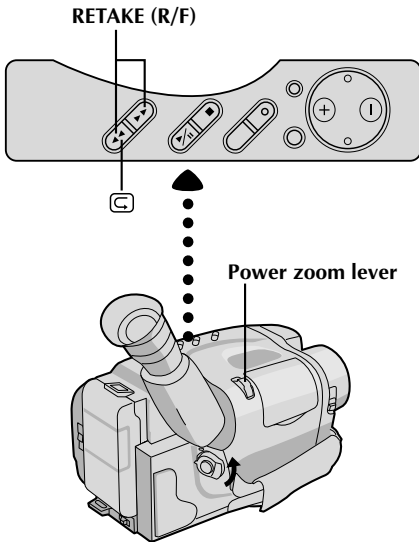
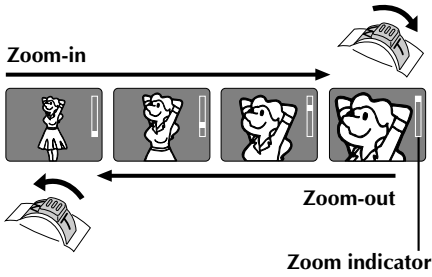

<p>FEATURE:</p> <p>PURPOSE:</p> <p>OPERATION:</p> <p>NOTES:</p>	<p>Zooming</p> <p>Varies the focal length of the lens and produces the zoom in/out effect.</p> <p>Zoom In</p> <p>1) Push the power zoom lever down towards "T".</p> <p>Zoom Out</p> <p>1) Push the lever up towards "W".</p> <p>• <i>The further the power zoom lever is pushed, the faster the zoom speed becomes.</i></p> <p>• <i>Focusing may become unstable during zooming. In this case, set the zoom while in Record-Standby, set manual focus or Focus Lock (📖 pgs. 18, 19), then zoom in or out in Record mode.</i></p>
<p>FEATURE:</p> <p>PURPOSE:</p> <p>OPERATION:</p> <p>NOTE:</p>	<p>Quick Review</p> <p>To check the end of the last recording.</p> <p>1) Press "⏮" and release quickly during the Record-Standby mode.</p> <p>• <i>Tape is rewound for about 2 seconds and played back automatically, then pauses in Record-Standby mode for the next shot.</i></p> <p>NOTE:</p> <p><i>Distortion may occur at start of playback. This is normal.</i></p>
<p>FEATURE:</p> <p>PURPOSE:</p> <p>OPERATION:</p> <p>NOTE:</p>	<p>Retake</p> <p>To re-record certain segments.</p> <p>1) Make sure the camcorder is in the Record-Standby mode.</p> <p>2) Press either RETAKE button to reach the start point for new recording.</p> <p>Pressing "F" fast-forwards the tape and pressing "R" reverses it.</p> <p>3) Press Recording Start/Stop button to start recording.</p> <p>NOTE:</p> <p><i>Noise may appear during Retake. This is normal.</i></p>

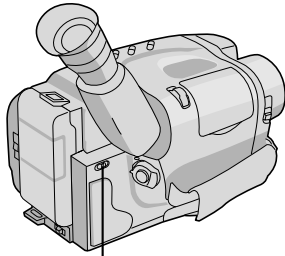

LIGHT OFF/AUTO/ON

Video Light

When natural lighting is too dim, you can brighten the scene by using the built-in video light.

SET VIDEO LIGHT

1 Set the **LIGHT OFF/AUTO/ON** as required.

ON : Always keeps the light on as long as the camcorder is turned on.

AUTO : Automatically turns on the light when the camcorder senses insufficient lighting on the subject.

OFF : Turns off the light.

- The video light can be used with the camcorder's power on.
- It is recommended to set the white balance (☞ pg. 23) to indoor mode (☞) when you use the video light.
- When not using the video light, turn it off to save battery power.

NOTES:

- Even if the battery indicator (☐) does not blink in the LCD monitor or the viewfinder, if the battery pack's charge is low, the camcorder may turn off automatically when you turn on the video light, or when you start recording with the video light turned on.
- When the **LIGHT OFF/AUTO/ON** switch is set to "AUTO":
 - Depending on the lighting conditions, the video light may keep turning on and off. In this case, manually switch the light on or off using the **LIGHT OFF/AUTO/ON** switch.
 - While the Sports or High-Speed Shutter mode (☞ pg. 17) is engaged, the light is likely to stay on.
 - While the Twilight mode (☞ pg. 17) is engaged, the light will not activate.

DANGER

- The video light can become extremely hot. Do not touch it either while in operation or soon after turning it off, otherwise serious injury may result.
- Do not place the camcorder into the carrying case immediately after using the video light, since it remains extremely hot.
- When operating, keep a distance of about 30 cm. between the video light and people or objects.
- Do not use near flammable or explosive materials.
- It is recommended that you consult your nearest JVC dealer for replacing the video light.

1 second later, the mode is activated.

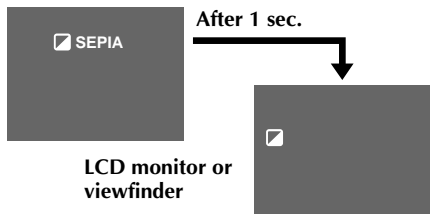

LCD monitor or
viewfinder

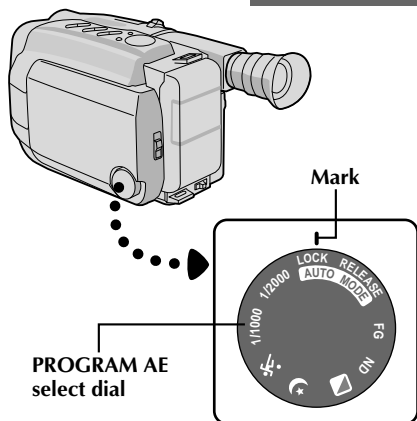

PROGRAM AE
select dial

Programme AE With Special Effects

All you have to do to access any of the variety of shooting effects is to turn the PROGRAM AE select dial.

SELECT MODE

1 Turn the PROGRAM AE select dial until the symbol of the function you want is aligned with the mark.

- The selected mode's name and its indication are displayed in the LCD monitor or the viewfinder for approx. 1 second. Then the name disappears, and only the indication remains. The mode is activated.
- When Auto Mode Lock or Auto Mode Release mode is selected, only the mode's name is displayed. Then the name disappears and the mode is activated.

NOTES:

- Only one effect can be engaged at a time.
- The screen becomes slightly reddish when the fader (☞ pg. 20) is used in the Sepia mode.
- The screen becomes slightly dark in the High Speed Shutter mode. Use in well-lit situations.
- In the High Speed Shutter or Sports modes, picture colour may be adversely affected if subject is lit by alternating discharge-type light sources such as fluorescent or mercury-vapour lights.

Dial symbol	LCD monitor/ Viewfinder indication	Mode
-------------	---------------------------------------	------

LOCK	AUTO LOCK	Auto Mode Lock
------	-----------	----------------

Auto Mode Lock

Locks the camcorder in Full Auto mode, preventing incorrect operation due to accidental button pressing during shooting.

- In this mode the following controls are disabled; FADE, WIDE, TITLE, DISPLAY, M.W.B. (Manual White Balance), Manual Focus, Focus Lock, Exposure Control and MENU

RELEASE	AUTO RELEASE	Auto Mode Release
---------	--------------	-------------------

Auto Mode Release

Re-enables the controls that were disabled by Auto Mode Lock.

Dial symbol	LCD monitor/ Viewfinder indication	Mode
-------------	---------------------------------------	------

FG	FG : FOG	Electronic Fog Filter
----	----------	-----------------------

Electronic Fog Filter

Makes the picture look misty white, as when an external fog filter is attached to the lens. Softens the image and gives it a "fancy" look.

ND	ND : ND EFFECT	ND Effect
----	----------------	-----------

ND Effect

A black mist darkens the picture, as when an ND filter is used. Helps to counter the effects of glare on the subject.

	SEPIA	Sepia
--	-------	-------

Sepia

The scene being shot is recorded in sepia-tinted (reddish-brown) monochrome, giving the effect of an older movie. Use together with Wide (☞ pg. 20) for the authentic look of a classic Hollywood movie.

Dial symbol	LCD monitor/ Viewfinder indication	Mode
	TWILIGHT	Twilight

Dial symbol	LCD monitor/ Viewfinder indication	Mode
	SPORTS	Sports

Twilight

Dusk, twilight scenery, fireworks, etc., look more natural and dramatic. The following happens when Twilight mode is selected:

- Auto gain control is turned off.
- White Balance is set to “☀” (outdoor mode), but can also be manually changed to another mode (☞ pg. 23).
- Auto Focus becomes available only in the range of 10 m to infinity. To focus when the subject-to-camera distance is less than 10 m, use manual focusing (☞ pg. 19).

Sports

High shutter speed clearly captures fast-moving action.

1/1000	S 1/1000	1/1000 sec. High Speed Shutter
--------	----------	-----------------------------------

1/2000	S 1/2000	1/2000 sec. High Speed Shutter
--------	----------	-----------------------------------

High-Speed Shutter (1/1000s., 1/2000s.)

Captures faster action than Sports mode.

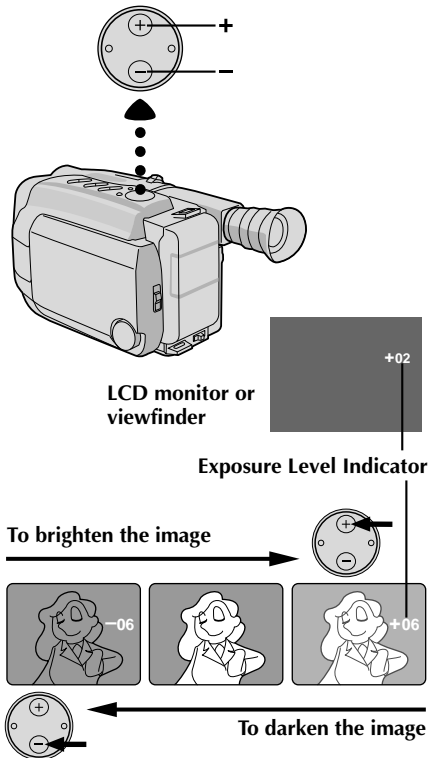

Exposure Control

This feature automatically adjusts the iris for the best available picture quality, but you can override and make the adjustment manually.

1 SELECT MODE

Turn the PROGRAM AE select dial to any position except AUTO LOCK.

2 BRIGHTEN IMAGE

Press + (maximum +06). The Exposure level indicator appears in the LCD monitor or the viewfinder.

OR . . .

DARKEN IMAGE

Press – (maximum –06). The Exposure level indicator appears in the LCD monitor or the viewfinder.

When you want to return to the factory setting . . .

3 RESTORE INITIAL SETTING

Press + and – simultaneously. The standard setting is immediately restored and the Exposure level indicator disappears.

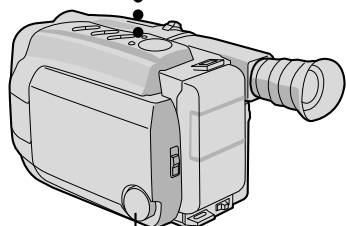
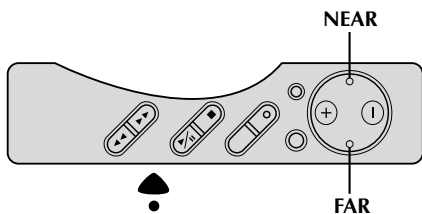
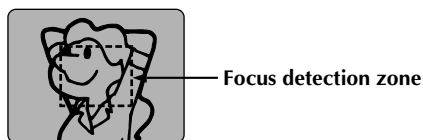

PROGRAM AE select dial

Focusing

Auto Focus

The camcorder's Full Range AF system offers continuous shooting ability from close-up to infinity. However, correct focus may not be obtainable in the situations listed below (in these cases use manual focusing):

- When two subjects overlap in the same scene.
- When illumination is low.*
- When the subject has no contrast (difference in brightness and darkness), such as a flat, one-colour wall, or a clear, blue sky.*
- When a dark object is barely visible in the viewfinder.*
- When the scene contains minute patterns or identical patterns that are regularly repeated.
- When the scene is affected by sunbeams or light reflecting off the surface of a body of water.
- When shooting a scene with a high-contrast background.

* The low-contrast warning “▲◀▶” appears in the LCD monitor or the viewfinder.

Focus Lock

This feature locks the focus in place, which is especially helpful in the following situations:

- When things pass between your subject and the camcorder. Engage the focus lock function to lock your subject in before recording.
- When you want your subject to be focused, and to appear in a corner of the screen. First, center on the subject and focus using auto focus mode. Then engage the focus lock function and move the camcorder until the subject is where you want it.

SELECT MODE

- 1 Turn the PROGRAM AE select dial to any position except AUTO LOCK.

LOCK FOCUS

- 2 Press **FAR** or **NEAR**. The focus lock indication “▲▶” appears in the LCD monitor or the viewfinder.

RELEASE FOCUS LOCK

- 3 Press **FAR** and **NEAR** simultaneously. The focus lock indication disappears.

NOTES:

- If the lens is smeared or blurred, accurate focusing is not possible. Keep the lens clean, wiping with a piece of soft cloth if it gets dirty. When condensation occurs, wipe with a soft cloth or wait for it to dry naturally.
- When shooting a subject close to the lens, zoom-out first (☞ pg. 14). If zoomed-in in the auto focus mode, the camcorder could automatically zoom out depending on the distance between the camcorder and the subject. *When Tele Macro (☞ pg. 25) is activated, the camcorder will not zoom out automatically.

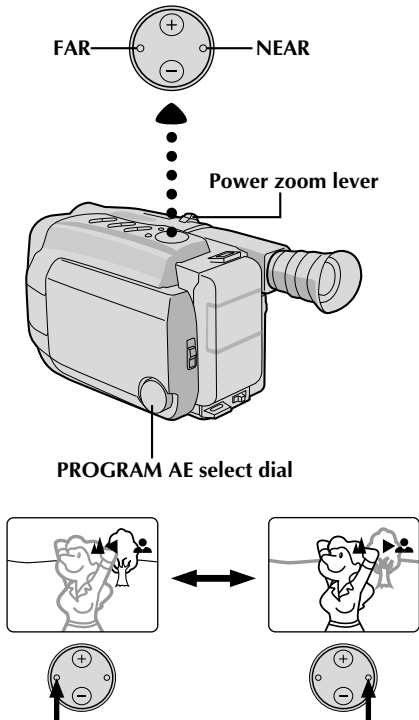

Manual Focus

NOTE:

You should already have made the necessary viewfinder adjustments (☞ pg. 6). If you haven't, do so before continuing.

SELECT MODE

- 1 Turn the PROGRAM AE select dial to any position except AUTO LOCK.

ADJUST FOCUS

2 To farther subject . . .

Press and hold **FAR**. The Manual Focus indications "▲◀ ▶" appear and "◀" blinks. Go to step 3.

To nearer subject . . .

Press and hold **NEAR**. The Manual Focus indications "▶ ▲▶" appear and "▶" blinks. Go to step 3.

LOCK FOCUS

- 3 Release **FAR** or **NEAR**. The focus indication is replaced by the focus lock indication "▲▶" and the adjusted focus is locked in.

RELEASE MANUAL FOCUS MODE

- 4 Press **FAR** and **NEAR** simultaneously. The Manual Focus mode is immediately released and the focus lock indication disappears.

NOTES:

- Be sure to focus the lens in the maximum telephoto position when you use the Manual Focus mode. If you focus in on a certain subject in the wide-angle position, sharply focused images cannot be obtained when zoomed up because the depth-of-field is reduced at longer focal lengths.
- When the focus level cannot be adjusted any farther or closer, "▲" or "▶" will blink.

FADE IN



FADE OUT

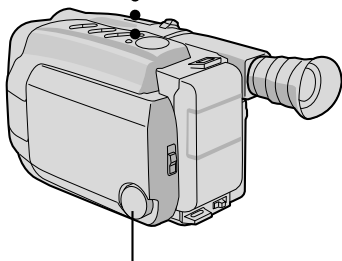
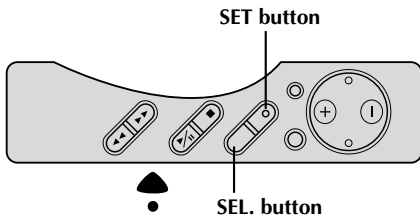
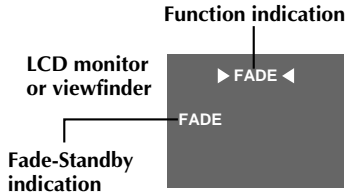

PROGRAM AE select dial

LCD monitor or viewfinder

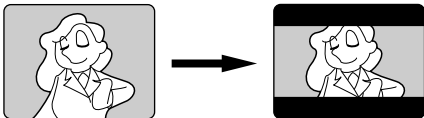

Wide mode

Fader

This feature allows smooth fade-in and fade-out to black blank screen. Fade-in works at recording start, and fade-out works at recording end or when you enter Record-Standby mode.

SELECT MODE

- 1 Turn the PROGRAM AE select dial to any position except AUTO LOCK.

SELECT FUNCTION

- 2 Press **SEL.** repeatedly until "▶FADE◀" appears.

ENGAGE FADE-STANDBY MODE

- 3 Press **SET** to engage the Fade-Standby mode. The Fade-Standby indication "FADE" is displayed.

START RECORDING

- 4 Press Recording Start/Stop to start recording and activate fade-in.

OR . . .

END RECORDING

- Press Recording Start/Stop to end recording and engage fade-out.

NOTES:

- Pressing and holding the Recording Start/Stop button allows you to record a black blank screen.
- The screen becomes slightly reddish when the Fader is used with Sepia (pg. 16).
- With the Electronic fog filter mode (pg. 16) engaged, the image fades in/out to a white screen.

Wide

This feature allows you to record black bars at the top and bottom of the screen to produce a cinema-like "wide-screen" effect.

SELECT MODE

- 1 Turn the PROGRAM AE select dial to any position except AUTO LOCK.

SELECT FUNCTION

- 2 Press **SEL.** repeatedly until "▶WIDE◀" appears.

ENGAGE WIDE MODE

- 3 Press **SET**.

RESTORE NORMAL SCREEN

- 4 Press **SET** again while "▶WIDE◀" appears.

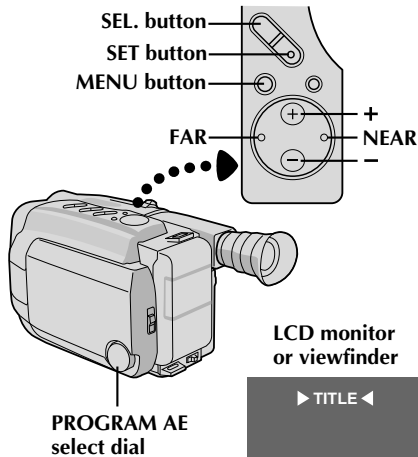

Instant Titles

The camcorder has eight preset titles in memory. You can superimpose one of them above a previously stored title as shown in the illustration to the left.

DISPLAY

1

SELECT MODE

Turn the PROGRAM AE select dial to any position except AUTO LOCK.

2

SELECT FUNCTION

Press **SEL.** repeatedly until "▶TITLE◀" appears.

3

SELECT PRESET TITLE

Engage the Record-Standby mode, then press **SET** to cycle through the preset titles until the desired title is displayed.

NOTES:

- To delete the Instant Title during recording, press **SET**.
- To recall a title, engage the Record-Standby mode and then press **SET** to select the desired title.

Character Generator

You can enter an original title of up to 18 characters.

1

ACCESS MENU SCREEN

Turn the PROGRAM AE select dial to any position except AUTO LOCK, then press **MENU**.

2

ACCESS CHARACTER SET MENU

Press **+** or **-** to move the highlight bar to "SET CHARACTER", then press **NEAR**. The Character Set menu appears.

3

INPUT CHARACTERS

Press **+**, **-**, **FAR** or **NEAR** to move the pointer to the desired character, then press **MENU**. The selected characters appear at the bottom of the screen. Repeat as many times as desired (max. 18).

- To select the location of the next character, press **+**, **-**, **FAR** or **NEAR** to highlight the row of squares at the bottom of the screen, then press **FAR** or **NEAR** to make the desired location blink. Press **+** when you're done, and the pointer returns to the character grid.

4

END CHARACTER SETTING

Press **+**, **-**, **FAR** or **NEAR** to make "END" blink, then press **MENU** twice to return to the normal screen.

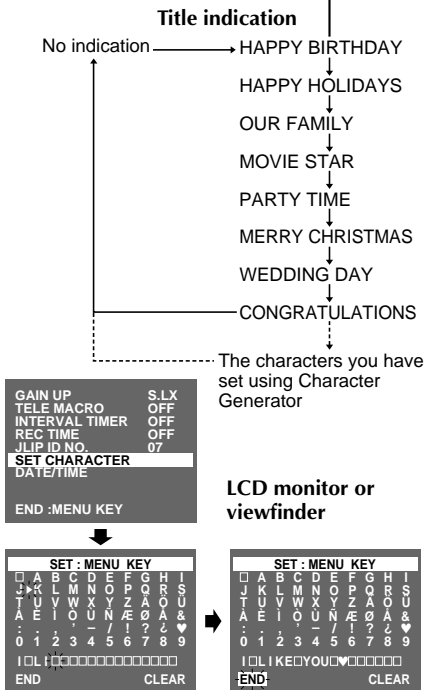

NOTES:

- To erase a character you entered mistakenly, make "CLEAR" blink by pressing **+**, **-**, **FAR** or **NEAR**, then press **MENU**. All characters are deleted at once. Or, to erase selected characters only, first move the pointer to the row of squares by pressing **+**, **-**, **FAR** or **NEAR** to highlight them. Press **FAR** or **NEAR** to make the desired character blink, then press **+**, **FAR** or **NEAR** to move the pointer to "□" in the top left corner. Press **MENU**.
- To display the characters you have set — "Instant Titles" or "Date/Time/Character Insert" (pg. 22).
- Characters may be set only in the Record-Standby mode.

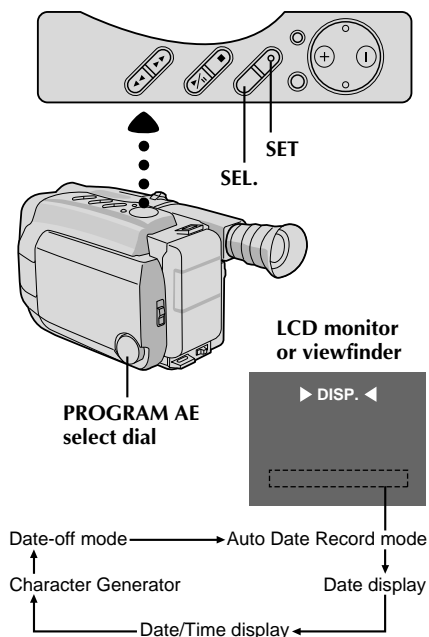

Date/Time Character Insert

This feature allows you to display date, time and characters in the LCD monitor or the viewfinder and on a connected colour monitor, record them manually or automatically, and even make your own titles.

NOTE:

You should already have performed the *Date/Time Setting procedure* (pg. 7). If you haven't, do so before continuing.

DISPLAY

1 SELECT MODE

Turn the **PROGRAM AE** select dial to any position except **AUTO LOCK**.

2 SELECT DISPLAY

Press **SEL.** repeatedly until "**▶DISP.◀**" appears.

3 CHOOSE DISPLAY MODE

Press **SET** while in Record-Standby to cycle through the modes as shown in the illustration at left.

NOTES:

- The selected display can be recorded.
- If you don't want to record the display, select **Date-off mode** before shooting.
- If you want to delete the display during shooting, press **SET**.
- If you want to call back a deleted display, engage the **Record-Standby mode** and then select the desired display mode using **SET**.

AUTO DATE RECORD

Your camcorder automatically records the date for about 5 seconds after recording is initiated in the following situations:

- After changing the date.
- After loading a cassette.
- After **Auto Date Record mode** is selected by pressing **SET**.

In this mode, the date is replaced after 5 seconds with "AUTO DATE".

NOTES:

- Setting **PROGRAM AE** to **LOCK** always engages this mode, and disables all other modes.
- In the **Auto Date Record mode**, if the date changes while you're shooting, the date indication is recorded for about 5 seconds from that point. It is not recorded during any other recordings made on that day.

Auto Date Record mode	
<p>AUTO DATE</p> <p>Auto date record mode</p>	<p>25.12.97</p> <p>Auto date record executed</p>
Date display	Date/Time display
<p>25.12.97</p>	<p>25.12.97 10:45</p>
Character Generator	
<p>SET CHAR</p> <p>No Characters stored</p>	<p>IN PARIS, FRANCE</p> <p>Example of stored characters</p>

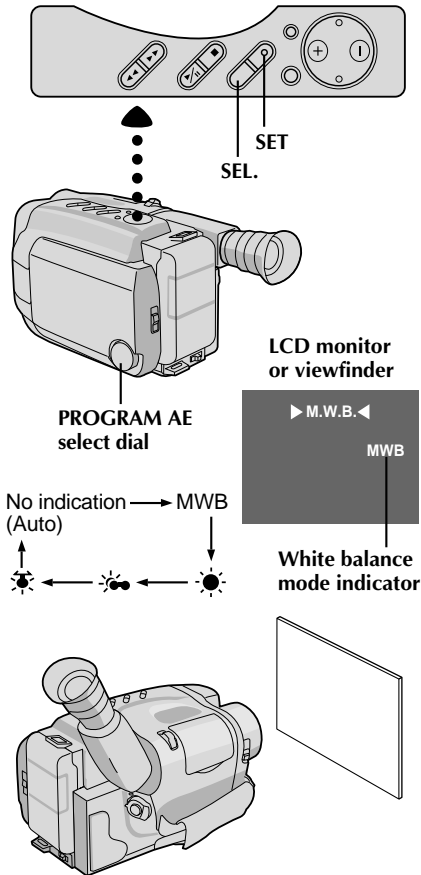

Manual White Balance Adjustment (M.W.B.)

This camcorder's Automatic Colour Temperature system senses the colour temperature of the ambient lighting for automatic white balance adjustment. However, precise colour adjustment is not possible under the following conditions:

- When an object is in various shades of the same colour.
- When a predominantly red or brown object is being shot outdoors.

In these cases, use the camcorder's built-in preset filters for white balance adjustment.

SELECT MODE

- 1 Turn the PROGRAM AE select dial to any position except AUTO LOCK.

SELECT FUNCTION

- 2 Press **SEL.** repeatedly until "►M.W.B.◀" appears.

SELECT WHITE BALANCE

- 3 Press **SET** (Manual White Balance) until the required indication appears in the LCD monitor or the viewfinder.

"MWB" With a memorized personal White Balance setting (see below)

"☀" Outdoors on sunny day

"☁" Outdoors on cloudy day

"☛" Light source is halogen or tungsten lamp

MWB

MWB sets the colour temperature for the subject's light source so you can shoot with natural colours that are unaffected by surroundings, even when there are multiple subjects with different colour temperatures.

SELECT MODE

- 1 Turn the PROGRAM AE select dial to any position except AUTO LOCK.

ADJUST FOCUS

- 2 Point the camcorder at a white, flat object such as a sheet of white paper, and adjust focus manually (☞ pg. 19).

ADJUST WHITE BALANCE

- 3 Press **SET** until "MWB" appears, then press and hold **SET** for more than 3 seconds.

- "MWB" blinks in the LCD moitor or the viewfinder during adjustment, then stops blinking but stays lit when adjustment is complete.

NOTES:

- To switch to automatic white balance adjustment, press **SET** until the indication disappears, or turn the PROGRAM AE select dial to "AUTO LOCK".
- Re-adjust the White Balance when the lighting has changed, when the camcorder has been turned on and off again, or when the PROGRAM AE select dial's position has been changed.
- When adjusted by putting coloured paper in front of the subject in step 2 ("ADJUST FOCUS"), this unit makes its colour temperature standard for automatic white balance. So you can enjoy shooting with different colours. For example, when adjusting with red, blue or yellow colours, the image becomes the colour which aproximates to green, orange or purple respectively.

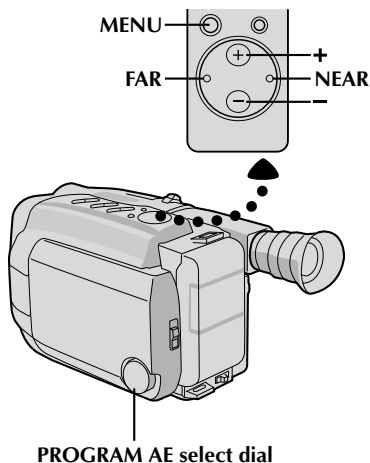

LCD monitor or viewfinder

GAIN UP	S.LX
TELE MACRO	OFF
INTERVAL TIMER	OFF
REC TIME	OFF
JLIP ID NO.	07
SET CHARACTER	
DATE/TIME	

END :MENU KEY



GAIN UP	▶ NORM
TELE MACRO	▶ ON
INTERVAL TIMER	1MIN
REC TIME	1/2S
JLIP ID NO.	07
SET CHARACTER	
DATE/TIME	

END :MENU KEY

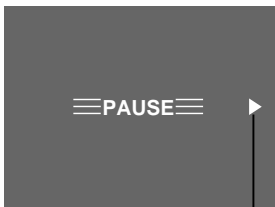

If GAIN UP or TELE MACRO in the Menu has been changed from the factory settings, this mark appears.

Using Menu For Detailed Adjustment

This camcorder is equipped with an easy-to-use, on-screen menu system that simplifies many of the more detailed camcorder settings.

1 SELECT MODE

Turn the PROGRAM AE select dial to any position except AUTO LOCK.

2 ACCESS MENU SCREEN

Press MENU.

3 SELECT FUNCTION

Press + or - to place the highlight bar on the desired function.

4 MAKE SETTING

The setting procedure depends on the function you select.

If you select GAIN UP, TELE MACRO, INTERVAL TIMER, REC TIME or JLIP ID NO. . . .

.... press FAR or NEAR to cycle through the choices until the desired setting appears.

If you select SET CHARACTER or DATE/TIME, . . .

.... press NEAR to access the selection menu for each function (SET CHARACTER – pg. 21; DATE/TIME – pg. 7).

5 CLOSE MENU

Press MENU. The normal screen reappears.

NOTE:

The menu is available only in the Record-Standby mode.

MENU

GAIN UP	S.LX	To record a subject in a dark lit environment. When it is more convenient to shoot the subject with a brighter image even if the picture becomes slightly coarse. Automatically selected when the PROGRAM AE select dial is set to AUTO LOCK mode. (S.LX : Super LoLux)
	▶ NORM	To record a subject in a dimly lit environment. When it is more convenient to shoot with a less coarse picture although the subject becomes slightly dark.
	▶ OFF	Allows you to shoot dark scenes with no picture brightness adjustment.
TELE MACRO	OFF	Usually set to this position.
	▶ ON	Usually the distance to a subject where the lens is in focus depends on the zoom magnification. Unless there is a distance more than 1m to the subject, the lens is out of focus at the maximum telephoto setting. When set to "ON", you can shoot a subject as large as possible at a distance of approx. 60 cm. <ul style="list-style-type: none"> Depending on the zoom position, the lens may go out of focus.
INTERVAL TIMER	OFF	This feature allows you to set the parameters for Self-Timer (☞ pg. 26) and Time-Lapse recording (☞ pg. 27).
	15 S	
	30 S	
	1 MIN	
REC TIME	OFF	This feature allows you to set the parameters for Animation and Time-Lapse recording (☞ pg. 27).
	1/4 S	
	1/2 S	
	1 S	
JLIP ID NO.	This number is necessary when connecting the camcorder to a device such as a computer using the J terminal (JLIP). The numbers range from 01 to 99. Factory setting is 07.	
SET CHARACTER	Allows you to input characters. (☞ pg. 21).	
DATE/TIME	Allows you to set the current date and time (☞ pg. 7).	

 = Factory setting and when the PROGRAM AE Select Dial is set to AUTO LOCK

NOTE:

During shooting in low light, Auto Focus accuracy may decrease even when GAIN UP is used. In this case, use Manual Focus (☞ pg. 19).

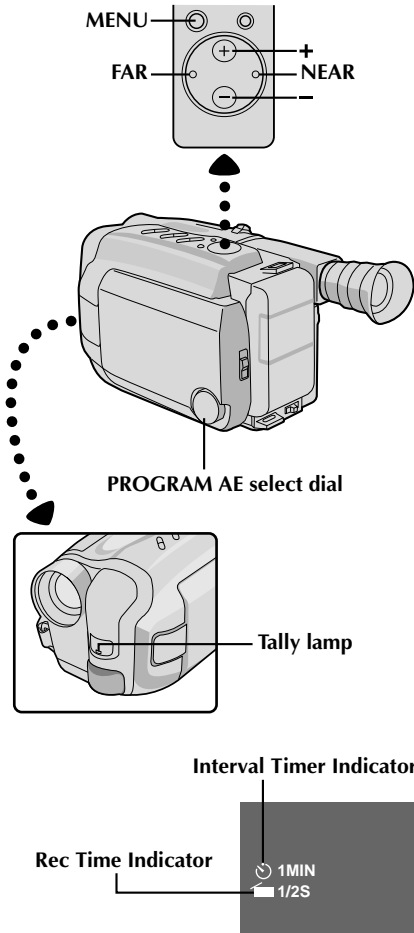

LCD monitor or viewfinder

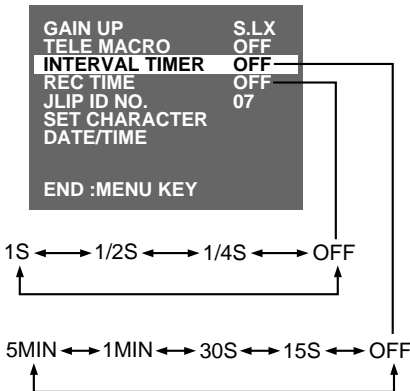

Self-Timer

You can set the delay between pressing the Recording Start/Stop button and the actual start of recording. If you secure the camcorder, you (or whomever is operating the camcorder) can enter the scene before recording starts.

NOTE:

Make sure the camcorder is in the Record-Standby mode before performing the following steps.

ACCESS MENU SCREEN

- 1 Turn the PROGRAM AE select dial to any position except AUTO LOCK, then press **MENU**.

SET INTERVAL TIME

- 2 Press - or + to move the highlight bar down to "**INTERVAL TIMER**", then press **FAR** or **NEAR** to cycle through the choices. Stop when the desired time appears. Choose from "15S", "30S", "1MIN", "5MIN", or select to turn the function "OFF".

CLOSE MENU

- 3 Press **MENU**.

START DELAYED RECORDING

- 4 Press the Recording Start/Stop button. The tally lamp begins blinking, and the blinking frequency increases about 5 seconds before recording is to start. Once recording begins, the lamp stops blinking but stays lit.

To Release Self-Timer . . .

... while the tally lamp is blinking, press the Recording Start/Stop button to stop the blinking, then set "**INTERVAL TIMER**" to "OFF".

Animation

Give stationary scenes or objects an illusion of movement. This function allows you to shoot a series of pictures, each slightly different, of the same object for a brief period of time.

NOTE:

Make sure the camcorder is in the Record-Standby mode and the recording mode is set to "SP" before performing the following steps.

- 1** Turn the PROGRAM AE select dial to any position except AUTO LOCK, then press **MENU**.
- 2** Press **-** or **+** to move the highlight bar down to "REC TIME", then press **FAR** or **NEAR** to cycle through the choices. Stop when the desired time appears. Choose from "1/4S", "1/2S", "1S", or select to turn the function "OFF". Then press **MENU** to close Menu screen.
- 3** Press the Recording Start/Stop button after focusing on the subject. The recording stops automatically after the selected period of time.
- 4** Repeat step 3 for the desired number of pictures.
- 5** Set "REC TIME" in the Menu screen to "OFF".

NOTES:

- For best results, make sure the camcorder is secured when shooting in Animation or Time-Lapse mode.
- Fade-in/out cannot be performed during Animation or Time-Lapse shooting.
- Before performing other operations following Animation or Time-Lapse recording, make sure the Animation or Time-Lapse mode is deactivated.

Time-Lapse

You can record sequentially at preset time spans. Leaving the camcorder aimed at a specific subject, you can record subtle changes over an extended period of time.

NOTE:

Make sure the camcorder is in the Record-Standby mode and the recording mode is set to "SP" before performing the following steps.

- 1** Turn the PROGRAM AE select dial to any position except AUTO LOCK, then press **MENU**.
- 2** Press **-** or **+** to move the highlight bar down to "INTERVAL BETWEEN RECORDINGS", then press **FAR** or **NEAR** to cycle through the choices. Stop when the desired time appears. Choose from "15S", "30S", "1MIN", "5MIN", or select to turn the function "OFF".
- 3** Press **-** or **+** to move the highlight bar down to "REC TIME", then press **FAR** or **NEAR** to cycle through the choices. Stop when the desired time appears. Choose from "1/4S", "1/2S", "1S", or select to turn the function "OFF". Then press **MENU** to close Menu screen.
- 4** Press the Recording Start/Stop button. Recording and intervals alternate automatically.
- 5** To release when the tally lamp is not blinking, set "REC TIME" and "INTERVAL TIMER" in the Menu screen to "OFF". To release when the tally lamp is blinking, press the Recording Start/Stop button to stop the blinking, then set "INTERVAL TIMER" and "REC TIME" in the Menu screen to "OFF".

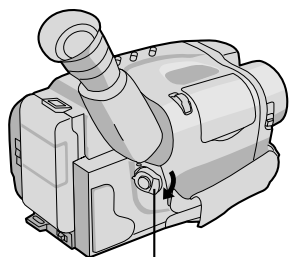

POWER

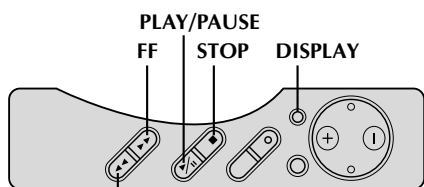

REW

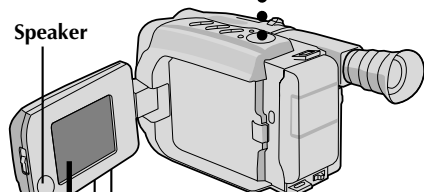

Speaker

BRIGHT

VOLUME

Recording mode indicator

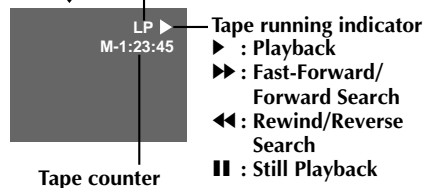

Tape counter

LCD Monitor in Retracted Position

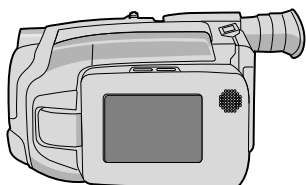

LOAD A CASSETTE

- 1 First slide MONITOR OPEN and open the LCD monitor to an angle of over 45 degrees. Press EJECT to open the cassette holder, then insert the cassette with the label facing out. Press PUSH to ensure the holder is closed and locked.

SELECT MODE

- 2 Make sure the LCD monitor is fully open. Then set the power switch to PLAY. The Power On indicator lights.

PLAYBACK

- 3 Press PLAY/PAUSE. The playback picture appears in the LCD monitor.

STOP PLAYBACK

- 4 Press STOP.

Rewind or Fast-forward the tape

Press REW to rewind, or FF to fast-forward the tape during Stop mode.

Adjust the brightness of the LCD monitor

To brighten the image, turn the BRIGHT dial towards "+". To darken the image, turn the dial towards "-".

Speaker volume control

You can adjust the speaker volume by turning the VOLUME dial.

ADJUST VOLUME

- 1 **If you want to turn up the volume . . .**
Turn the dial towards "+".
If you want to turn down the volume . . .
Turn the dial towards "-".

NOTES:

- The camcorder shuts off automatically after about 5 minutes in Stop mode. To turn on again, set the power switch to POWER OFF, then to PLAY.
- When the power switch is set to PLAY and the LCD monitor is opened at an angle of 45 degrees or more, the LCD monitor switches on and the viewfinder switches off automatically to save power.
- When the LCD monitor is turned off, sound is not heard from the speaker.
- The playback picture can also be viewed in the viewfinder (with the LCD monitor shut) or on a connected TV (pg. 30). Camcorder operation is the same as described in this section.
- You can also view the playback picture on the LCD monitor with it flipped over and retracted.
- During playback, pressing DISPLAY lets you remove all indications from the screen.

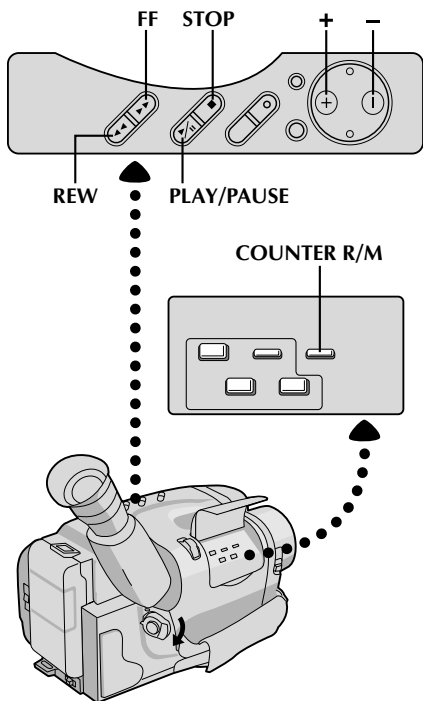

<p>FEATURE: PURPOSE:</p> <p>OPERATION:</p> <p>NOTES:</p>	<p>Manual Tracking</p> <p>To eliminate noise bars that appear on the screen during playback.</p> <p>1) Press either +/- button as many times as necessary for best picture.</p> <p>● To reset <i>TRACKING</i> to the original preset, press both + and - buttons simultaneously.</p> <p>● Manual Tracking may not work with tapes recorded on other VCRs or camcorders.</p>
<p>FEATURE: PURPOSE: OPERATION:</p> <p>NOTE:</p>	<p>Still Playback</p> <p>To pause during playback.</p> <p>1) Press PLAY/PAUSE during playback.</p> <p>2) To resume normal playback, press PLAY/PAUSE again.</p> <p>NOTE: Noise bars appear and pictures may become monochrome during Still Playback. This is normal.</p>
<p>FEATURE: PURPOSE:</p> <p>OPERATION:</p> <p>NOTE:</p>	<p>Shuttle Search</p> <p>To allow high-speed search in either direction.</p> <p>Forward Search</p> <p>1) Press FF during playback.</p> <p>Reverse Search</p> <p>1) Press REW during playback.</p> <p>NOTE: Noise bars appear and pictures may become monochrome or darken in Shuttle Search. This is normal.</p>
<p>FEATURE: PURPOSE: OPERATION:</p> <p>NOTES:</p>	<p>Counter Memory Function</p> <p>To make it easier to locate a specific tape segment.</p> <p>1) Press COUNTER R/M and hold for more than 2 seconds. The counter resets to "0:00:00".</p> <p>2) Press COUNTER R/M. "M" appears.</p> <p>3) After recording or playback, press STOP, then REW. The tape automatically stops at or close to 0:00:00.</p> <p>4) Press PLAY/PAUSE to start playback.</p> <p>● The counter memory functions in the Fast-Forward and Rewind modes.</p> <p>● To disable Counter Memory Function, press COUNTER R/M less than 1 second so the "M" disappears.</p>

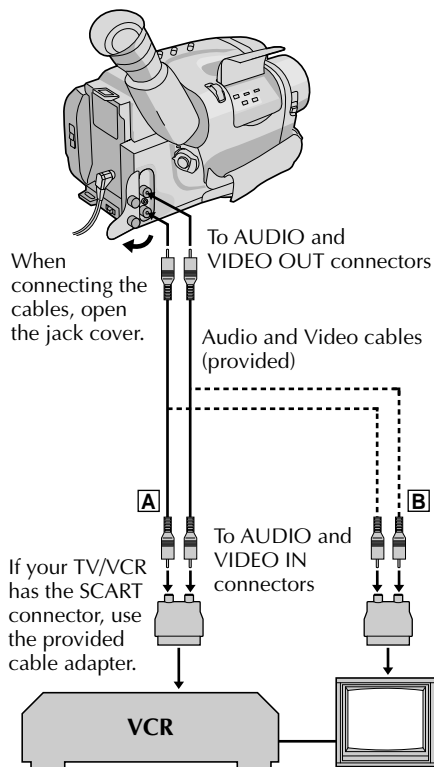

There are two basic types of connections. When making the connections, refer also to your VCR and TV instruction manuals.

Connection To A VCR [A] (Editing, Dubbing and Playback)

NOTE:

Use the provided Audio and Video cables.

CONNECT CAMCORDER TO VCR

- 1 As shown in the illustration at left, connect the Audio and Video cables between the AUDIO and VIDEO connectors on the camcorder and those on the VCR.

SUPPLY POWER

- 2 Turn on the camcorder, the VCR and the TV.

SELECT MODE

- 3 Set the VCR to its AUX input mode, and set the TV to its VIDEO mode.

Connection To A TV With A/V Input Connectors [B] (Playback ONLY)

NOTE:

Use the provided Audio and Video cables.

CONNECT CAMCORDER TO TV

- 1 As shown in the illustration at left, connect the Audio and Video cables between the AUDIO and VIDEO connectors on the camcorder and those on the TV.

SELECT MODE

- 2 Set the TV to its VIDEO or AV mode (as specified in its instructions).

NOTES:

- It is recommended to use the AC Power Adapter/Charger as the power supply instead of the battery pack.
- To monitor the picture and sound from the camcorder without inserting a tape, set the camcorder's Power switch to "CAMERA", then set your TV to the appropriate input mode.
- If you have a TV or speakers that are not specially shielded, do not place the speakers adjacent to the TV as interference will occur in the camcorder playback picture.

Cassette Adapter

Use this to play back a VHS-C video cassette recorded with this camcorder. It is fully compatible with any VHS video cassette recorder. The C-P7U adapter is battery powered and automatically performs tape loading and unloading.

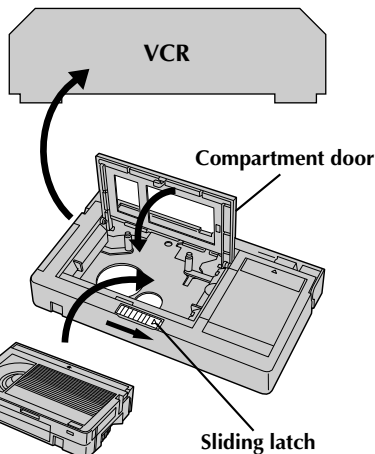
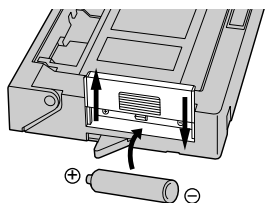

Compact video cassette

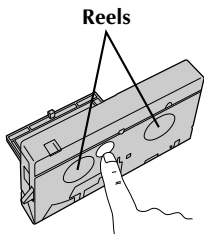

1 INSERT BATTERY

Slide the battery cover up to remove it, and install one "R6(AA)" size battery as shown in the illustration at left. Then reattach the cover.

2 INSERT CASSETTE IN ADAPTER

Slide the latch to open the adapter compartment door, then insert the cassette and close the compartment door.

3 PLAY BACK ON CONNECTED VCR

Load the cassette adapter into the VCR and play the tape back as you would any other.

4 REMOVE CASSETTE FROM ADAPTER

Slide the latch and the compartment door opens automatically. Then insert your finger in the hole on the underside of the adapter as shown in the illustration at left, push up and remove the cassette.

NOTES:

- During tape loading and unloading, do not touch the reels for safety and tape protection.
- During special-effect playback (slow motion, still frame, etc.), the picture may vibrate or noise bars may appear on the screen.
- To record on a VCR using a compact cassette and the adapter, cover the adapter's recording safety hole with adhesive tape.

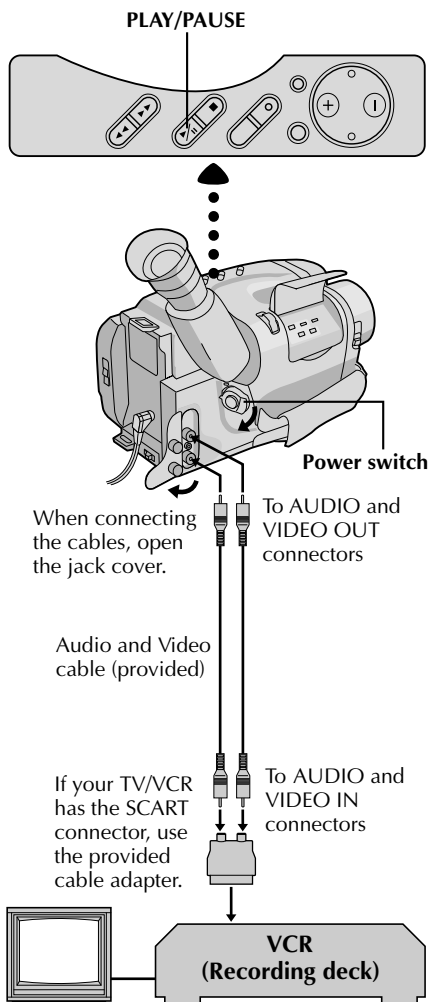

Tape Dubbing

CONNECT EQUIPMENT

- 1 Following the illustration at left, connect the camcorder and the VCR.

PREPARE FOR DUBBING

- 2 Set the camcorder's Power switch to "PLAY", turn on the VCR's power, and insert the appropriate cassettes in the camcorder and the VCR.

SELECT VCR MODE

- 3 Engage the VCR's AUX and Record-Pause modes.

FIND EDIT-IN POINT

- 4 Engage the camcorder's Play mode to find a spot just before the edit-in point. Once it's reached, press **PAUSE** on the camcorder.

START EDITING

- 5 Press **PLAY** on the camcorder and engage the VCR's Record mode.

STOP EDITING TEMPORARILY

- 6 Engage the VCR's Record-Pause mode and press **PAUSE** on the camcorder.

EDIT MORE SEGMENTS

- 7 Repeat steps 4 through 6 for additional editing, then stop the VCR and camcorder when finished.

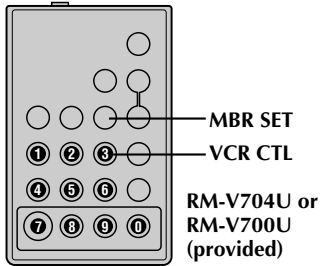

VCR CODE LIST

VCR BRAND NAME	BUTTONS (A) (B)	VCR BRAND NAME	BUTTONS (A) (B)
AKAI	6 2 6 4 7 7	PHILIPS	1 9 9 5 1 1 9 4 9 1 9 6 1 2 3 3
BLAUPUNKT	1 3	SANYO	3 6 3 5
FERGUSON	9 7 9 8 3 2	SELECO, REX	9 1 9 6
GRUNDIG	1 4 3 4	SHARP	1 5 1 0
HITACHI	6 6 6 3	SONY	6 5 6 0 3 9 3 1
JVC A B C	9 1 9 6 9 3	THOMSON, TELEFUNKEN, SABA, NORDMENDE	9 1 9 6 9 7 3 2
MITSUBISHI	6 7 6 3	TOSHIBA	6 9 6 1
NEC	3 7 3 8		
PANASONIC	1 3 1 7 1 1 9 4 1 8		

NOTES:

- If the VCR's power doesn't come on in step 1, try another code from the VCR CODE LIST.
- Some brands of VCR don't come on automatically. In this case, turn the power on manually and try step 2.
- If the RM-V704U/V700U is not able to control the VCR, use the controls on the VCR.

Random Assemble Editing [R.A.Edit]

Create edited videos easily using your camcorder as the source player. You can select up to 8 "cuts" for automatic editing, in any order you like. R.A.Edit is more easily performed when the MBR (Multi-Brand Remote RM-V704U or RM-V700U) is set to operate with your brand of VCR (see VCR CODE LIST), but can also be performed by operating the VCR manually.

SET REMOTE/VCR CODE

Before operation, make sure the lithium battery is installed in the remote control RM-V704U or RM-V700U (see pg. 36).

1 SET REMOTE TO OPERATE VCR

Turn off the power to the VCR and point the remote toward the VCR's infrared sensor. Then, referring to the VCR CODE LIST on the left, press and hold **MBR SET**, and press button (A) and then (B).

- The code is automatically set once you release the **MBR SET** button, and the VCR's power comes on.

2 OPERATE THE VCR

Make sure the VCR's power is on. Then, while holding **VCR CTL**, press the button on the remote for the desired function. The functions the remote can control are PLAY, STOP, PAUSE, FF, REW and VCR REC STBY (you don't need to press **VCR CTL** for this one).

You're now ready to try Random Assemble Editing.

IMPORTANT

Although the MBR is compatible with JVC VCRs and those of many other makers, it may not work with yours or may offer limited functions.

MAKE CONNECTIONS

1 CONNECT TO . . .

- JVC VCR EQUIPPED WITH REMOTE PAUSE TERMINAL**
Connect the editing cable to the Remote PAUSE terminal.
- JVC VCR NOT EQUIPPED WITH REMOTE PAUSE TERMINAL BUT EQUIPPED WITH R.A. EDIT CONNECTOR**
Connect the editing cable to the R.A.EDIT connector.
- VCR OTHER THAN TYPE A OR B**
Connect the editing cable to the RM-V704U/V700U's Pause-In jack.

All other connections are as shown in the illustration on page 34.

CONTINUED ON NEXT PAGE

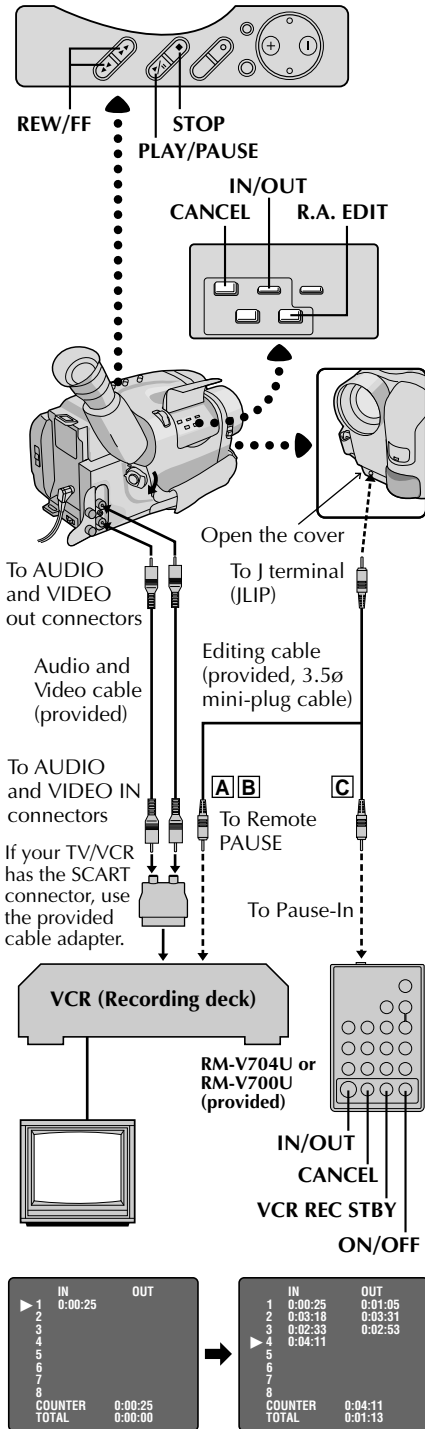

2 PREPARE CAMCORDER
 Insert a recorded tape and set the Power switch to "PLAY".

3 PREPARE VCR
 Turn the power on, insert a recordable tape and engage the AUX mode (refer to VCR's instructions).

SELECT SCENES

1 ACCESS R.A. EDIT COUNTER DISPLAY
 Press **PLAY/PAUSE**, then press **R.A. EDIT** and the counter display appears in the viewfinder or the LCD monitor and the screen of the connected TV.

2 REGISTER BEGINNING OF SCENE
 Press **REW** or **FF** to locate the beginning of a scene you want, then press **IN/OUT** to register that point. The data appears under "IN" on the display.

3 REGISTER END OF SCENE
 Press **REW** or **FF** to locate the end of the scene and press **IN/OUT** to register it. The data appears under "OUT" on the display. The total time of the registered scene(s) is displayed at the bottom of the screen.

4 REGISTER ADDITIONAL SCENES
 Repeat steps 2 and 3 for each additional scene (as many as 8).

5 MAKE CORRECTIONS
 Press **CANCEL** during steps 2 and 3 to erase the most recently registered point.

NOTES:

- The RM-V704U/V700U can be used to operate other camcorder functions as well. Point the RM-V704U/V700U at the camcorder's remote sensor and press any of the following buttons (function appears in parentheses):
 - ON/OFF (camcorder R.A. EDIT)
 - IN/OUT (camcorder IN/OUT)
 - CANCEL (camcorder CANCEL)
- There must be at least one second between an in-point and its corresponding out-point.
- To ensure correct operation, leave at least 15 seconds open between scenes.
- Blank portions of tape cannot be registered as in-points or out-points.
- If it takes more than 5 minutes to search for an in-point, the VCR's Record-Pause mode is cancelled and editing doesn't take place.
- Pressing **R.A.EDIT** clears all in- and out-points from memory.
- Leave a small margin for error around each in-point to ensure the scene is recorded in its entirety.

ORIGINAL TAPE (camcorder)

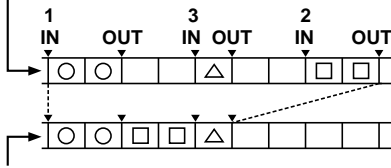

EDITED TAPE (VCR)

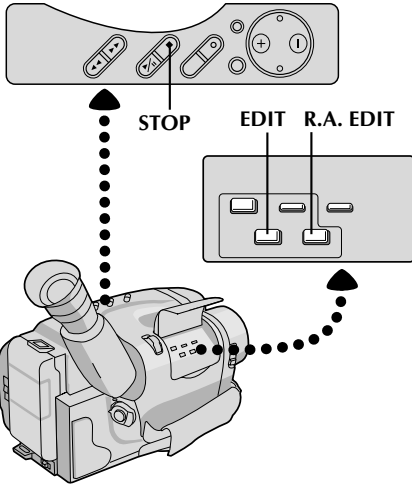

AUTOMATIC EDITING TO VCR

ENGAGE VCR'S RECORD-PAUSE MODE

- 1 Point the remote control toward the VCR's infrared sensor and press **VCR REC STBY**, or manually engage the VCR's Record-Pause mode.

BEGIN AUTOMATIC EDITING

- 2 Press **EDIT** on the camcorder, and the previously selected scenes are copied to the VCR in the specified order.

END AUTOMATIC EDITING

- 3 When all selected scenes have been copied, the camcorder and VCR enter the still or pause mode. Press **STOP** on both units. To make the R.A. Edit counter display disappear, press **R.A.EDIT**.

- When finished editing, be sure to disconnect the editing cable and the audio/video cable.

NOTES:

- If you performed step 1  on page 33 ("MAKE CONNECTIONS"), keep the remote control pointed at the VCR during editing.
- The on-screen display only appears while the camcorder searches for each scene.
- There may be noise at in- or out-points on the edited tape with certain VCRs.

SUPPLEMENTAL INFORMATION ON THE REMOTE CONTROL

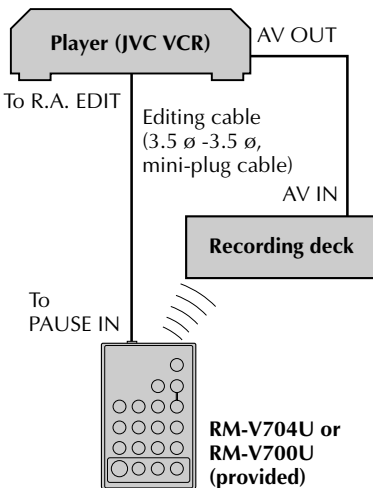

Using the RM-V704U/V700U, it is also possible to perform deck-to-deck Random Assemble Editing. The playback deck must be an R.A. Edit-capable JVC VCR. The recording deck can be . . .

- a VCR other than JVC, or
- a JVC VCR which has **neither** a Remote PAUSE nor an R.A. EDIT connector

How to use:

- Connect the playback deck and RM-V704U/V700U as shown on the left.
- Set the RM-V704U/V700U to correspond to the brand of the recording deck. ( pg. 33)
- For Random Assemble Editing procedure, please refer to the instruction manual of the JVC VCR you are using as the playback deck.

Notes:

- RM-V704U/V700U cannot be used to control the playback deck.
- RM-V704U/V700U is capable of controlling basic operations of the recording deck. While pressing VCR CTL, press PLAY, STOP, PAUSE, FF or REW for these functions. (Not possible with some brands and models). Other buttons cannot be used.
- To put the recording deck in the Record-Pause mode, use the controls on the recording deck itself.

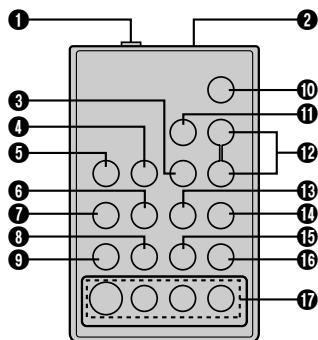
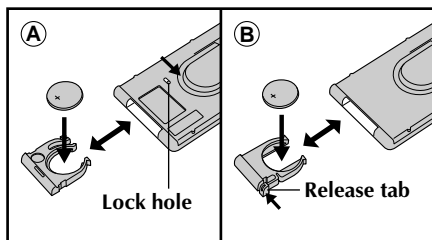

RM-V704U or RM-V700U (provided)

The Full-Function Remote Control Unit can operate this camcorder from a distance as well as the basic operations (PLAY, STOP, PAUSE, FF, and REW) of your VCR. This remote control unit makes additional recording functions possible.

Installing The Battery

1 PULL OUT BATTERY HOLDER

Pull out the battery holder according to the type of remote control unit you have.

Type A : Pull out the battery holder while sliding the lock hole.

Type B : Pinch the release tab and pull out the battery holder.

2 INSERT BATTERY

Making sure the plus (+) side is up, insert the lithium battery (CR2025)* into the battery holder.

3 REPLACE BATTERY HOLDER

Insert the battery holder into the remote control unit, and push the holder until it clicks into place.

* Read the caution concerning lithium batteries (☞ pg. 2).

BUTTONS	FUNCTIONS	
	With the camcorder's power switch set to "CAMERA".	With the camcorder's power switch set to "PLAY".
① PAUSE IN Connector	—	☞ pg. 34
② Infrared beam transmitting window	Transmits the beam signal.	
③ MBR SET Button	—	☞ pg. 33
④ INT. TIME Button	Self-Timer/Time-Lapse (☞ pg. 37)	—
⑤ REC TIME Button	Animation/Time-Lapse (☞ pg. 37)	—
⑥ FF Button	Retake (forward) (☞ pg. 14)	FF/FF Shuttle Search (☞ pg. 29)
⑦ REW Button	Retake (rewind)/Quick Review (☞ pg. 14)	Rew/Rew Shuttle Search (☞ pg. 29)
⑧ PAUSE Button	—	Pause (☞ pg. 29)
⑨ PLAY Button	—	Playback start (☞ pg. 28)
⑩ START/STOP Button	Functions same as the Recording Start/Stop button on the camcorder.	
⑪ VISS Button	Index Code marking (☞ pg. 37)	—
⑫ ZOOM (T/W) Buttons	Zoom in and out (☞ pg. 14)	—
⑬ VCR CTL Button	—	☞ pg. 33
⑭ A.DUB Button	—	Audio dubbing (☞ pg. 39)
⑮ STOP Button	—	Stop (☞ pg. 28)
⑯ INSERT Button	—	Insert Editing (☞ pg. 38)
⑰ R.A.EDIT Buttons	—	☞ pg. 34

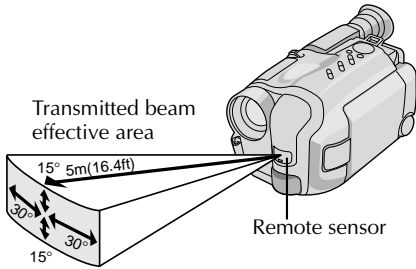

When using the remote control, be sure to point it at the remote sensor. The above illustration shows the approximate transmitted beam effective area for indoor use. The transmitted beam may not be effective or may cause incorrect operation outdoors or when the remote sensor is directly exposed to sunlight or powerful lighting.

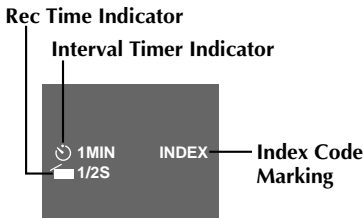

LCD monitor or viewfinder

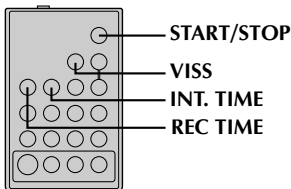
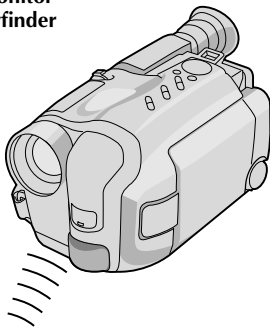

RM-V704U or RM-V700U (provided)

FEATURE:
PURPOSE:

OPERATION:

Self-Timer, Animation and Time-Lapse

The remote control lets you set/release Interval Timer and Rec Time functions as well as the Menu screen.

Self-Timer

1) Set

Instead of performing steps **1** through **3** on pg. 26 (“Self-Timer”), press **INT. TIME** on the remote control. Each time **INT. TIME** is pressed, the Interval Timer indicator appears, changing in the following order: 15S, 30S, 1MIN, 5MIN and No indication (off).

2) Release

Instead of setting “INTERVAL TIMER” to “OFF” in the Menu, press **INT. TIME** on the remote control until the Interval Timer indicator disappears.

Animation

1) Set

Instead of performing steps **1** and **2** on pg. 27 (“Animation”), press **REC TIME** on the remote control. Each time **REC TIME** is pressed, the Rec Time indicator appears, changing in the following order: 1/4S, 1/2S, 1S and No indication (off).

2) Release

Instead of using the Menu in step 5 on pg. 27, press **REC TIME** on the remote control until the Rec Time indicator disappears.

Time-Lapse

1) Set

Instead of performing steps **1** through **3** on pg. 27 (“Time-Lapse”), press **INT. TIME** and **REC TIME** on the remote control. Each time **INT. TIME** is pressed, the Interval Timer indicator appears, changing in the following order: 15S, 30S, 1MIN, 5MIN and No indication (off). Each time **REC TIME** is pressed, the Rec Time indicator appears, changing in the following order: 1/4S, 1/2S, 1S and No indication (off).

2) Release

Instead of using the Menu in step 5 on pg. 27, press **INT. TIME** and **REC TIME** on the remote control until the indicators disappear.

NOTE:

Also refer to pgs. 26 and 27.

FEATURE:
PURPOSE:

OPERATION:

NOTE:

Index Code Marking

To give you automatic access to any selected point on a recording.

1) Press VISS once to place the index code. “INDEX” blinks in the LCD monitor or the viewfinder during marking.

If **VISS** is pressed during Record-Standby mode, the mark is placed where **START/STOP** is pressed.

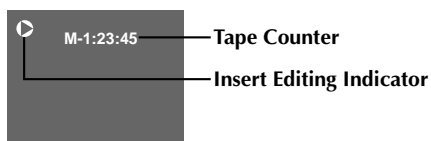
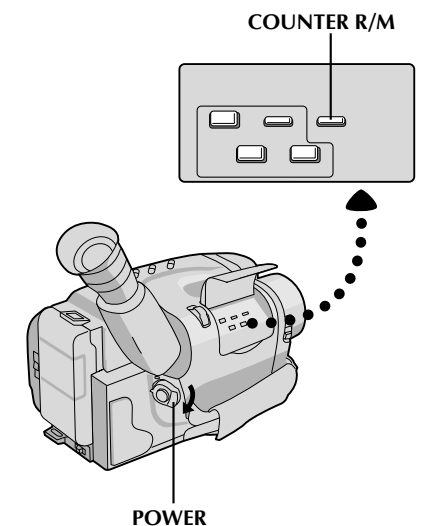

LCD monitor or
viewfinder

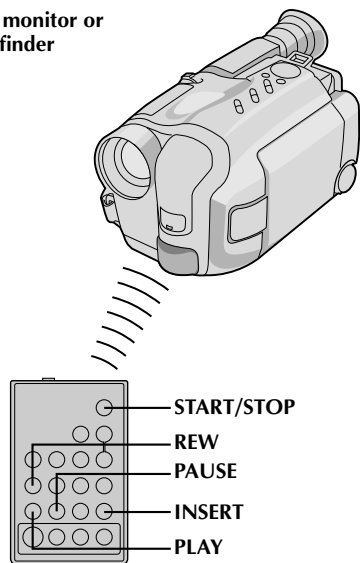

RM-V704U or
RM-V700U (provided)

Insert Editing

You can record a new scene into a previously recorded tape, replacing a section of the original recording with minimal picture distortion at the in- and out-points. The original audio remains unchanged.

NOTE:

Use the RM-V704U or RM-V700U remote control unit to perform this procedure.

SELECT MODE

- 1 Set the Power switch to "PLAY".

FIND EDIT-OUT POINT

- 2 Play back the tape, locate the Edit-Out point and press **PAUSE** on the camcorder or the remote control.

RESET COUNTER

- 3 Press and hold **COUNTER R/M** for more than 2 seconds to reset the tape counter, then press for less than 1 second and make sure "M" appears in the LCD monitor or the viewfinder.

FIND EDIT-IN POINT

- 4 Press **REW** to go a little beyond the beginning of the scene you want to replace, press **PLAY** to view the recorded tape, and press **PAUSE** at exactly at the Edit-in point where the new scene should start.

ENGAGE INSERT EDITING MODE

- 5 Press and hold **INSERT**, and without releasing **INSERT**, press and release **PAUSE**. The Insert mode is engaged, and the scene the camcorder is aimed at appears on the screen.

BEGIN INSERT EDITING

- 6 Press **START/STOP**. When the counter reaches "0:00:00", editing stops automatically and the camcorder enters the Insert-Pause mode.

END INSERT EDITING

- 7 Press **STOP**.

NOTES:

- When Insert Editing is performed with the LCD monitor fully opened, the original audio will be heard from the speaker.
- After step 5, Retake (see pg. 14) can be performed.
- The tape may stop slightly before or after the designated end point, and noise bars may appear. Neither indicates a defect in the unit.
- Only video signal is recorded in the Insert Editing mode.

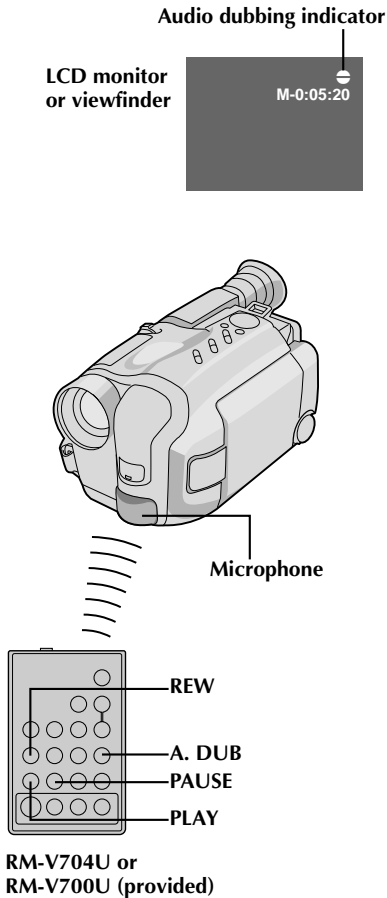

Audio Dubbing

You can record a new soundtrack on a prerecorded tape (normal audio only).

** Perform steps 1, 2 and 3 of the Insert Editing procedure (pg. 38) before continuing.

- The sound comes from the built-in microphone.

FIND EDIT-IN POINT

- 1 Press **REW** to go a little beyond the beginning of the scene onto which you want to dub new audio, press **PLAY** to view the recorded tape, then press **PAUSE** at exactly the point where dubbing should start.

ENGAGE AUDIO DUB STANDBY MODE

- 2 Press and hold **A. DUB**, and without releasing **A. DUB**, press and release **PAUSE**.

BEGIN AUDIO DUBBING

- 3 Press **PLAY**. When the counter reaches "0:00:00", Audio Dubbing stops automatically and the camcorder enters the Audio Dub-Standby mode.

END AUDIO DUBBING

- 4 Press **STOP**.

NOTES:

- Do not press **FF** or **REW** during Audio Dub-Standby, or the edit points will not be accurate.
- If the microphone is too close to the TV, or if the TV's volume is too high, whistling or howling may occur.

NOTES (for Insert Editing and Audio Dubbing):

- Insert Editing and Audio Dubbing may not work correctly if the tape contains blank segments, or if the recording speed was changed during the original recording.
- To edit/dub onto a tape with the recording safety tab removed, cover the hole with adhesive tape.
- Do not press **STOP** during Insert Editing or Audio Dubbing, or the edit points will not be accurate.
- During Insert Editing and Audio Dubbing, when Insert-Pause or Audio Dub-Standby is engaged, the counter may go slightly past "0:00:00". Recording, however, stops at exactly 0:00:00.







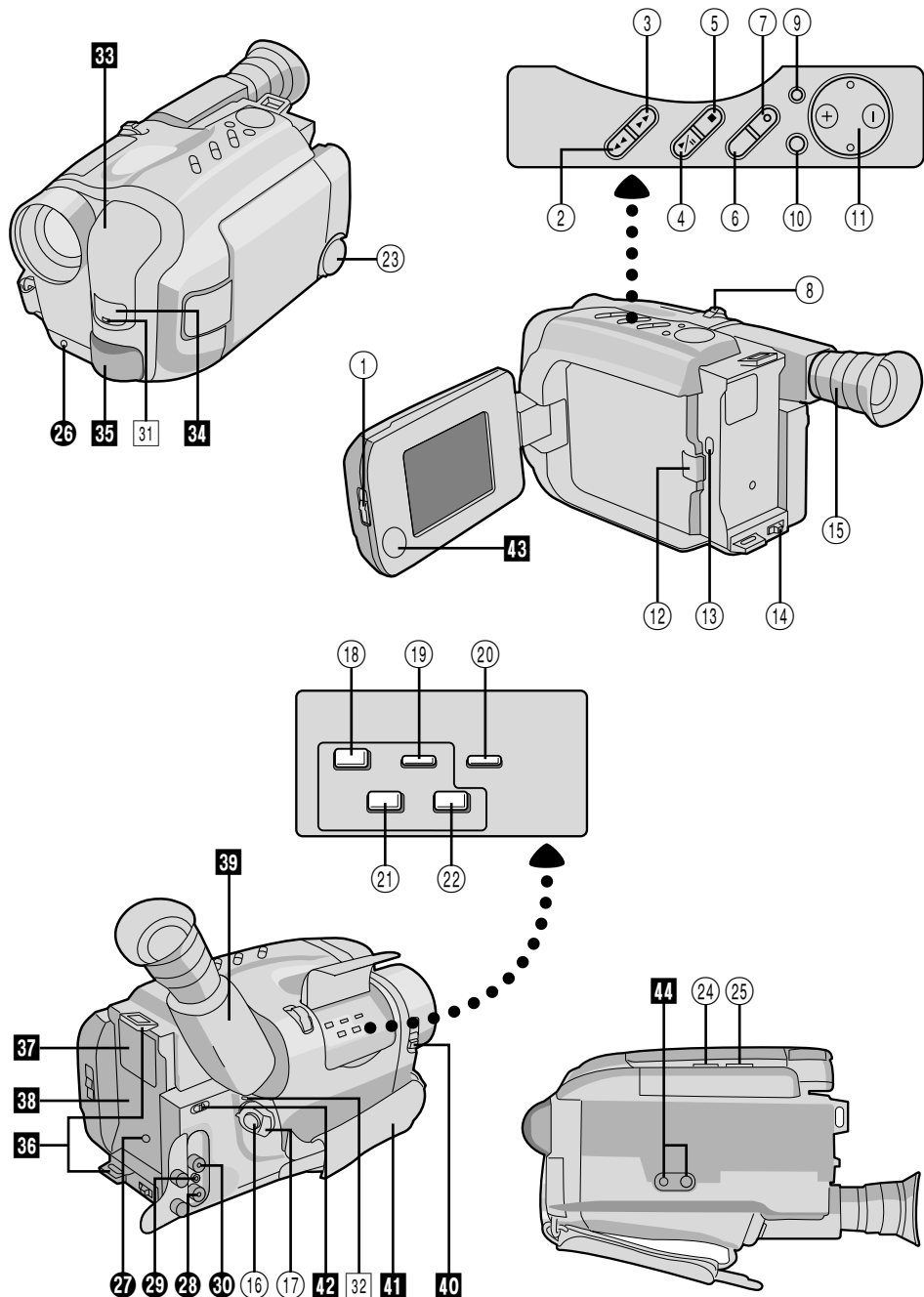

























SYMPTOM	POSSIBLE CAUSE(S)
POWER	
No power is supplied.	<ul style="list-style-type: none"> ● The battery pack has not been attached correctly (☞ pg. 4). ● The battery pack is not charged (☞ pg. 4). ● The power supply has not been correctly connected (☞ pg. 5).
The power suddenly goes off and doesn't come back on by itself.	<ul style="list-style-type: none"> ● The battery pack has completely discharged. ● Remove the cassette and disconnect the power source, then after a few minutes, try turning the power back on. If it still doesn't come on, consult your nearest JVC dealer.
RECORDING	
Recording cannot be performed.	<ul style="list-style-type: none"> ● The recording tape's Erase Protection tab is missing. Cover the hole with adhesive tape. (Some tapes have sliding tabs. In this case, check the position of the tab.)
Recording does not start.	<ul style="list-style-type: none"> ● The camcorder Power switch has not been set to "CAMERA" (☞ pg. 10).
PLAYBACK	
The tape is running, but there's no playback picture.	<ul style="list-style-type: none"> ● The TV has not been set to its VIDEO mode. ● If A/V connection is used, the TV's VIDEO/TV switch has not been set to VIDEO.
Noise bars appear in the playback picture.	<ul style="list-style-type: none"> ● Manual Tracking has not been performed (☞ pg. 29).
Playback picture is blurred or interrupted.	<ul style="list-style-type: none"> ● The video heads are dirty or worn out. Consult your nearest JVC dealer for head cleaning or replacement.
The counter indication is blurred during Still playback.	<ul style="list-style-type: none"> ● This is normal.
TAPE TRANSPORT	
The tape stops during fast-forward or rewind.	<ul style="list-style-type: none"> ● The Counter Memory Function has been activated (☞ pg. 29).
Rewinding or fast-forwarding cannot be performed.	<ul style="list-style-type: none"> ● The tape is already fully wound on one reel or the other.

SYMPTOM	POSSIBLE CAUSE(S)
OTHER	
The tape won't eject.	<ul style="list-style-type: none"> ● The battery pack is running low. ● If the LCD monitor is not open over 45 degrees, EJECT switch does not function.
Some functions are not available.	<ul style="list-style-type: none"> ● The PROGRAM AE select dial is set to "AUTO LOCK".
Vertical white lines appear when shooting a very bright object.	<ul style="list-style-type: none"> ● This sometimes occurs when the contrast between the background and the object is great. It is not a defect of the camcorder.
Bright, crystal-shaped spots appear in the LCD monitor and the viewfinder.	<ul style="list-style-type: none"> ● Sunlight is directly entering the lens. This is not a defect of the camcorder.
The picture is blurred in the Quick Review or Retake mode.	<ul style="list-style-type: none"> ● This is normal while recording in the LP mode. Some noise may be present while recording in the SP mode (☞ pg. 8).
The rear of the LCD monitor is hot.	<ul style="list-style-type: none"> ● The light used to illuminate the LCD monitor causes it to be hot. Close the LCD monitor to turn it off or set the power switch to OFF, and let the unit cool down.
Coloured bright spots appear all over the LCD monitor.	<ul style="list-style-type: none"> ● The LCD monitor is made with high-precision technology. However, black spots or bright spots of light (red, green or blue) may appear constantly on the LCD monitor. These spots are not recorded on the tape. This is not due to any defect of the unit. (Effective dots: more than 99.99 %.)
The indicators and the picture colour on the LCD monitor are not clear.	<ul style="list-style-type: none"> ● This may occur when the surface or the edge of the LCD monitor is pressed.
The LCD monitor, the viewfinder and the lens have become dirty (ex. fingerprints).	<ul style="list-style-type: none"> ● Wipe them gently with soft cloth. Gently wipe the LCD monitor in a semicircle because wiping strongly spreads the stain and it won't come out easily.
An error number (i.e. E03) appears in the LCD monitor or the viewfinder.	<ul style="list-style-type: none"> ● Turn the camcorder's power off, then disconnect the power source. After a few minutes, try turning the power on again. If the error number still appears in the LCD monitor or the viewfinder, consult your nearest JVC dealer.
The image is out of focus.	<ul style="list-style-type: none"> ● The dioptre needs to be adjusted (☞ pg. 6). ● The scene being shot is adversely affecting the operation of Auto Focus (☞ pg. 18).
A character generator title and the date and time displays disappear from the LCD monitor or the viewfinder.	<ul style="list-style-type: none"> ● If you remove the power source from the camcorder while the power is on, all settings and selections are erased. Make sure to turn the camcorder's power off before disconnecting the power source.
Even though the Lens Cover is open, the Lens Cover Warning indicator blinks.	<ul style="list-style-type: none"> ● The Lens Cover Warning indicator may blink when the camcorder is used in dark areas, regardless of the position of the Lens Cover.





The camcorder is a microcomputer-controlled device. External noise and interference (from a TV, a radio, etc.) might prevent it from functioning properly. In such cases, first disconnect its power supply unit (battery pack, AC Power Adapter/Battery Charger, etc.) and clock battery; and then re-connect it and proceed as usual from the beginning.





Controls

- ① MONITOR OPEN Switch  pg. 12
- ② REW Button  pg. 28
RETAKE R [Quick Review] Button  pg. 14
- ③ FF Button  pg. 28
RETAKE F Button  pg. 14
- ④ PLAY/PAUSE Button  pg. 28
- ⑤ STOP Button  pg. 28
- ⑥ SEL. Button  pg. 20
- ⑦ SET Button  pg. 20
- ⑧ Power Zoom Lever  pg. 14
- ⑨ DISPLAY Button  pg. 11
- ⑩ MENU Button  pg. 21
- ⑪ Multi-Function Control
 - Exposure +/-  pg. 17
 - Focus FAR/NEAR  pg. 18
 - Menu Setting Change  pg. 24
 - Tracking +/-  pg. 29
- ⑫ PUSH Button  pg. 8
- ⑬ EJECT Switch  pg. 8
- ⑭ BATT. [Battery] RELEASE Switch  pg. 4
- ⑮ Dioptre Adjustment  pg. 6
- ⑯ Recording Start/Stop Button  pg. 10
- ⑰ POWER Switch  pg.10, 28
- ⑱ • Recording Mode [SP/LP]
Select Button  pg. 8
• R.A. EDIT CANCEL Button  pg. 34
- ⑲ R.A.EDIT IN/OUT Button  pg. 34
- ⑳ Tape Length [T30•45•60]
Select Button  pg. 8
COUNTER R [Reset]/M [Memory]
Button  pg. 29
- ㉑ EDIT Button  pg. 35
- ㉒ R.A.EDIT Button  pg. 34
- ㉓ PROGRAM AE Select Dial  pg. 16
- ㉔ BRIGHT Dial  pg. 28
- ㉕ VOLUME Dial  pg. 28













Connectors

- ㉖ J terminal (JLIP (Joint Level Interface Protocol) Connector.)
(Located beneath the jack cover)
 - Connect the Editing Cable when performing Random Assemble Editing ( pg. 34).
 - It is used to connect the camcorder to a device such as a personal computer.
For further detail consult your nearest JVC dealer.
- ㉗ DC IN Jack  pg. 5
The jacks ㉖ to ㉘ are located beneath the jack cover.
- ㉘ VIDEO OUT Jack  pg. 30
- ㉙ RF DC OUT Jack
- ㉚ AUDIO OUT Jack  pg. 30

Indicators

- ㉛ Tally Lamp  pg. 10
- ㉜ Power On Indicator  pg. 10

Other Parts

- ㉝ Video Light  pg. 15
- ㉞ • Camera sensor
Be careful not to cover this area; built-in here is the sensor necessary for shooting.
• Remote sensor  pg. 37
- ㉟ Microphone  pg. 39
- ㊱ Shoulder Strap Eyelets  pg. 9
- ㊲ Clock Battery Compartment  pg. 6
- ㊳ Battery Pack Mount  pg. 4
- ㊴ Electronic Viewfinder  pg. 6
- ㊵ LENS COVER Switch  pg. 10
- ㊶ Grip Strap  pg. 9
- ㊷ VIDEO LIGHT OFF/AUTO/ON
Switch  pg. 15
- ㊸ Speaker  pg. 28
- ㊹ Tripod Mounting Socket  pg. 9

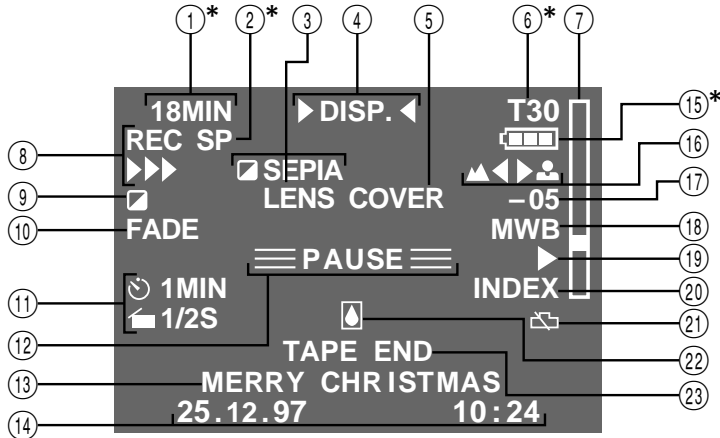

LCD monitor/Viewfinder Indications

- ①* Cassette Warning/Remaining
Tape Time pg. 11
When no cassette is inserted or when Erase Protection tab is not in the position that allows recording, the Cassette (🔒) Warning blinks. Otherwise, the Remaining Tape Time is displayed.
- ②* Recording Mode [SP/LP] Indicator pg. 8
- ③, ⑨ PROGRAM AE Indicator pg. 16
Displayed at ③ for approx. 1 second when the PROGRAM AE select dial is switched from one position to another. Then only the indicator remains at ⑨.
- ④ Program Manager Function
Indication pg. 20
Appears when the PROGRAM AE select dial is set to any position other than AUTO LOCK.
- ⑤ Lens Cover Warning pg. 11
- ⑥* Tape Length Display pg. 8
- ⑦ Zoom Level Indicator pg. 14
- ⑧ Recording Indicator pg. 10
- ⑩ Fade-Standby Indicator pg. 20
- ⑪ Interval Time/Recording
Time Indicator pg. 26
- ⑫ Record-Standby Mode Indicator pg. 10
- ⑬ Instant Title Display pg. 21
- ⑭ Date/Time Character Display pg. 22
- ⑮* Battery Pack Remaining Power Indicator
Changes as follows according to the battery pack's remaining power level: "🔋→🔋→🔋→🔋". When the power is almost gone, the indicator blinks, then the unit shuts off. Replace the battery pack with a fully charged one. (**Note:** The symbol containing 3 darkened squares — 🔋 — does not necessarily mean that the battery pack is fully charged.)
- ⑯ Focus Indicator pg. 18
- ⑰ Exposure Level Indicator pg. 17
- ⑱ White Balance Mode Indicator pg. 23
- ⑲ Menu Setting Change Indicator pg. 24
- ⑳ Index Code Marking pg. 37
- ㉑ Clock Warning
Displayed for about 5 seconds if the clock (lithium) battery is not in place or is exhausted when power is turned on. Also displayed for about 5 seconds when clock battery becomes exhausted while using the camcorder. For inserting or replacing the clock battery pg. 6
- ㉒ Condensation Warning
When this indication appears, all functions are disabled. Turn the unit off (without removing the power source) for a few hours, and when you turn it on again the indicator should disappear.
- ㉓ Tape End Display pg. 11
Appears when the end of the tape is reached during playback, recording or fast-forward.

* : During recording, pressing DISPLAY lets you remove indications marked with * from the screen.

DANGER:

Video Light

- The video light becomes extremely hot. Do not touch it either while in operation or soon after turning it off, otherwise serious injury may result.
- Do not place the camcorder into the carrying case immediately after using the video light, since it remains extremely hot.
- When operating, keep a distance of about 30 cm between the video light and people or object.
- Do not use near flammable or explosive materials.
- Consult your nearest JVC dealer for replacing the video light unit.

General Battery Precautions

- When the C-P6U or C-P7U (cassette adapter) is not functioning even when correctly operated, the batteries are exhausted. Replace them with fresh ones.
- Use only the following batteries:
C-P6U or C-P7U R6 (AA) size

Please make note of the following rules for battery use. When misused, batteries can leak or explode.

1. Refer to the instructions when replacing the battery.
2. **Do not** expose batteries to excessive heat as they can leak or explode.
3. **Do not** dispose of batteries in a fire.
4. Remove batteries from the unit if it is to be stored for an extended period to avoid battery leakage which can cause malfunctions.

Battery Packs

The supplied battery pack is a nickel-cadmium battery. Before using the supplied battery pack or an optional battery pack, be sure to read the following cautions:

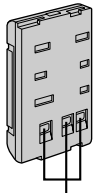

Terminals

1. **To avoid hazard . . .**
 - **do not** burn.
 - **do not** short-circuit the terminals.
 - **do not** modify or disassemble.
 - use only specified chargers.
2. **To prevent damage and prolong service life . . .**
 - **do not** subject to unnecessary shock.
 - avoid repeated charging without fully discharging.

- charge in an environment where temperatures are within the tolerances shown in the chart below. This is a chemical reaction type battery—cooler temperatures impede chemical reaction, while warmer temperatures can prevent complete charging.
- store in a cool, dry place. Extended exposure to high temperatures will increase natural discharge and shorten service life.
- avoid prolonged uncharged storage.
- remove from charger or powered unit when not in use, as some machines use current even when switched off.

3. To prevent damage to the camcorder . . .

- replace the battery pack when it begins to deliver less recording time per charge.

NOTES:

- *It is normal for the battery pack to be warm after charging, or after use.*
Temperature Ranges
Charging 10°C to 35°C
Operation 0°C to 40°C
Storage -10°C to 30°C
- *Recharging time is based on room temperature of 20°C.*
- *The lower the temperature, the longer recharging takes.*

Cassettes

To properly use and store your cassettes, be sure to read the following cautions:

1. During use . . .

- make sure the cassette bears the VHS-C mark.
- be aware that recording onto prerecorded tapes automatically erases the previously recorded video and audio signals.
- make sure the cassette is positioned properly when inserting.
- do not load and unload the cassette repeatedly without allowing the tape to run at all. This slackens the tape and can result in damage.
- do not open the front tape cover. This exposes the tape to fingerprints and dust.

2. Store cassettes . . .

- away from heaters or other heat sources.
- out of direct sunlight.
- where they won't be subject to unnecessary shock or vibration.
- where they won't be exposed to strong magnetic fields (such as those generated by motors, transformers or magnets).
- vertically, in their original cases.

Main Unit

1. For safety, DO NOT . . .

- open the camcorder's chassis.
- disassemble or modify the unit.
- short-circuit the terminals of the battery pack. Keep it away from metallic objects when not in use.
- allow inflammables, water or metallic objects to enter the unit.
- remove the battery pack or disconnect the power supply while the power is on.
- leave the battery pack attached when the camcorder is not in use.

2. Avoid using the unit . . .

- in places subject to excessive humidity or dust.
- in places subject to soot or steam such as near a cooking stove.
- in places subject to excessive shock or vibration.
- near a television set.
- near appliances generating strong magnetic or electric fields (speakers, broadcasting antennas, etc.).
- in places subject to extremely high (over 40°C) or extremely low (under 0°C) temperatures.

3. DO NOT leave the unit . . .

- in places of over 50°C.
- in places where humidity is extremely low (below 35%) or extremely high (above 80%).
- in direct sunlight.
- in a closed car in summer.
- near a heater.

4. To protect the unit, DO NOT . . .

- allow it to become wet.
- drop the unit or strike it against hard objects.
- subject it to shock or excessive vibration during transportation.
- keep the lens directed at extremely bright objects for long periods.
- direct the eyepiece of the viewfinder at the sun.
- carry it by holding the viewfinder or the LCD monitor. Be sure to hold the main unit with both hands or use the grip.
- swing it excessively when using the shoulder strap.

5. This camcorder features a built-in head cleaner which automatically cleans the heads and head drum when a cassette is loaded or unloaded. If, however, the heads become dirty and cause blurriness or interruption in the playback picture, consult your nearest JVC dealer.

LCD monitor

1. To prevent damage to the LCD monitor, DO NOT . . .

- push it strongly or apply any shocks.
- place the camcorder with the LCD monitor on the bottom.

2. To prolong service life . . .

- avoid rubbing it with coarse cloth.

3. Make be aware of the following phenomena for LCD monitor use. These are not malfunctions. . . .

- While using the camcorder, the surface around the LCD monitor and/or the back of the LCD monitor may heat up.
- If you leave power on for a long time, the surface around the LCD monitor becomes hot.

About moisture condensation . . .

- You have observed that pouring a cold liquid into a glass will cause drops of water to form on the glass' outer surface. This same phenomenon occurs on the head drum of a camcorder when it is moved from a cool place to a warm place, after heating a cold room, under extremely humid conditions or in a place directly subjected to the cool air from an air conditioner.
- Moisture on the head drum can cause severe damage to the video tape, and can lead to internal damage to the camcorder itself.

Serious malfunctioning

If malfunctioning occurs, stop using the unit immediately and consult your local JVC dealer.

For Your Maintenance

1. After Use

- ① Set the power switch to POWER OFF to turn off the camcorder.
- ② Press EJECT to open the cassette holder, then remove the cassette.
- ③ Close and lock the cassette holder by pressing PUSH.
- ④ Close and lock the LCD monitor.
- ⑤ Press BATT. RELEASE to remove the battery pack.
- ⑥ Slide the LENS COVER open/close switch to close the lens cover.



2. Cleaning The Camcorder

- ① **CLEAN EXTERIOR**
Wipe gently with a soft cloth.
- ② **CLEAN LCD MONITOR**
Slide MONITOR OPEN to open the LCD monitor and wipe gently with soft cloth. Be careful not to damage the monitor. Close the LCD monitor.
- ③ **CLEAN LENS**
Blow it with a blower brush, then wipe gently with lens cleaning paper.
- ④ **REMOVE EYEPIECE**
Turn the eyepiece counterclockwise and pull it out.
- ⑤ **CLEAN VIEWFINDER**
Remove dust using a blower brush.
- ⑥ **RE-ATTACH EYEPIECE**
Align the marks, re-attach the eyepiece and turn it clockwise.

NOTES:

- Avoid using strong cleaning agents such as benzine or alcohol.
- Cleaning should be done only after the battery pack has been removed or other power units have been disconnected.
- Mould may form if the lens is left dirty.

GENERAL

Format	: VHS PAL standard
Power source	: DC 6 V 
Power consumption	
LCD monitor off, viewfinder on	: 6.3 W
LCD monitor on, viewfinder off	: 6.7 W
Light	: 3 W
Signal system	: PAL-type
Video recording system	
Luminance	: FM recording
Colour	: Converted sub-carrier direct recording Conforms to VHS standard
Cassette	:  cassette
Tape speed	
SP	: 23.39 mm/sec
LP	: 11.70 mm/sec
Recording time Max.	
SP	: 60 minutes (with EC-60 cassette)
LP	: 120 minutes (with EC-60 cassette)
Operating temperature	: 0°C to +40°C
Operating humidity	: 35% to 80%
Storage temperature	: -20°C to +50°C
Weight	: Approx. 1040 g
Dimensions	: 118 (W) x 115 (H) x 231 (D) mm

CAMERA

Pick up	: 1/4" format CCD
Lens	: F1.6, f = 3.8 to 68.4 mm, 18:1 power zoom lens with auto iris and macro control, filter diameter 46 mm
Viewfinder	: Electronic viewfinder with 0.5" B/W CRT
White balance adjustment	: Auto/Manual adjustment

LCD MONITOR

Size	: 3" diagonally measured
LCD system	: LCD/TFT active matrix system



VIDEO

Output	: 1 Vp-p, 75 ohms, unbalanced (via VIDEO out connector)
--------	---

AUDIO

Output	: -8 dBs, 1 k-ohm (via AUDIO out connector)
Speaker	: 20 mm round x 1, monaural

AC POWER ADAPTER/BATTERY CHARGER (AA-V11EG)

Power requirement	: AC 110 to 240 V \sim , 50/60 Hz
Power consumption	: 23 W
Output	: DC 8.5 V  , 1.3 A (CHARGE), DC 6.3 V  , 1.8 A (VTR)
Charging system	: Constant current, peak detection, timer controlled
Dimensions	: 150 (W) x 42 (H) x 68 (D) mm
Weight	: Approx. 350 g

CASSETTE ADAPTER (C-P7U)

Dimensions	: 188 (W) x 25 (H) x 104 (D) mm
Weight	: Approx. 240 g
Accessory	: "R6 (AA)"-size battery x 1

Provided Accessories pg. 3

Optional Accessories

- **Battery Packs BN-V12U, BN-V22U, BN-V25U**
- **Car Battery Charger BH-V3E**
- **Compact VHS-C Cassettes EC-60/45/30**
- **Active Carrying Bag CB-V7U**
- **Wireless Remote Control Unit RM-V704U or RM-V700U**

Some accessories are not available in some areas. Please consult your nearest JVC dealer for details on accessories and their availability.

Specifications shown are for SP mode unless otherwise indicated. E.&O.E. Design and specifications subject to change without notice.

EN

GR-AXM30

JVC

VICTOR COMPANY OF JAPAN, LIMITED